

A**S641-KOM2D4S****ANGA**

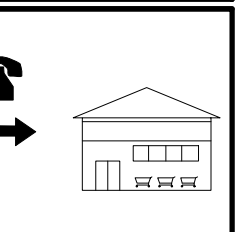

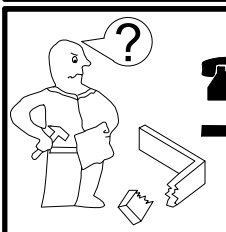

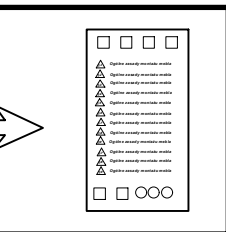

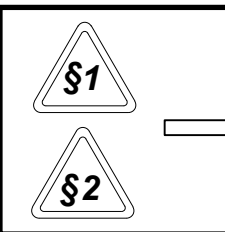
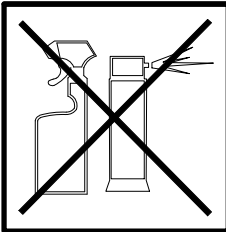
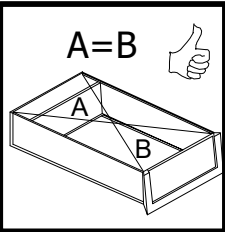
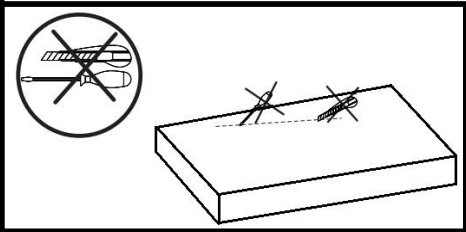
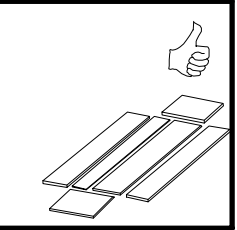
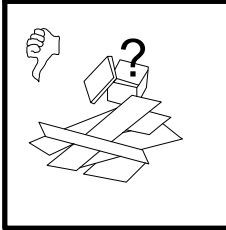
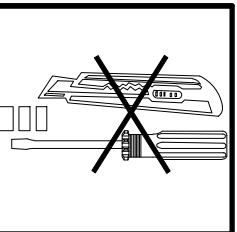
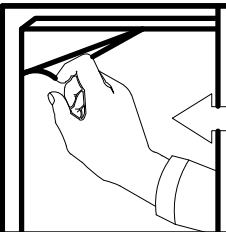
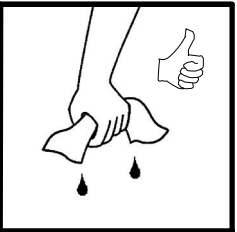
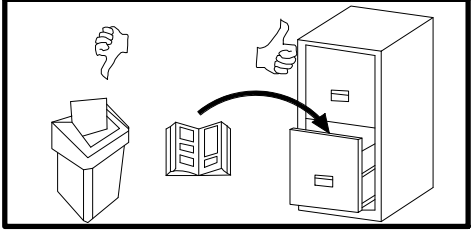
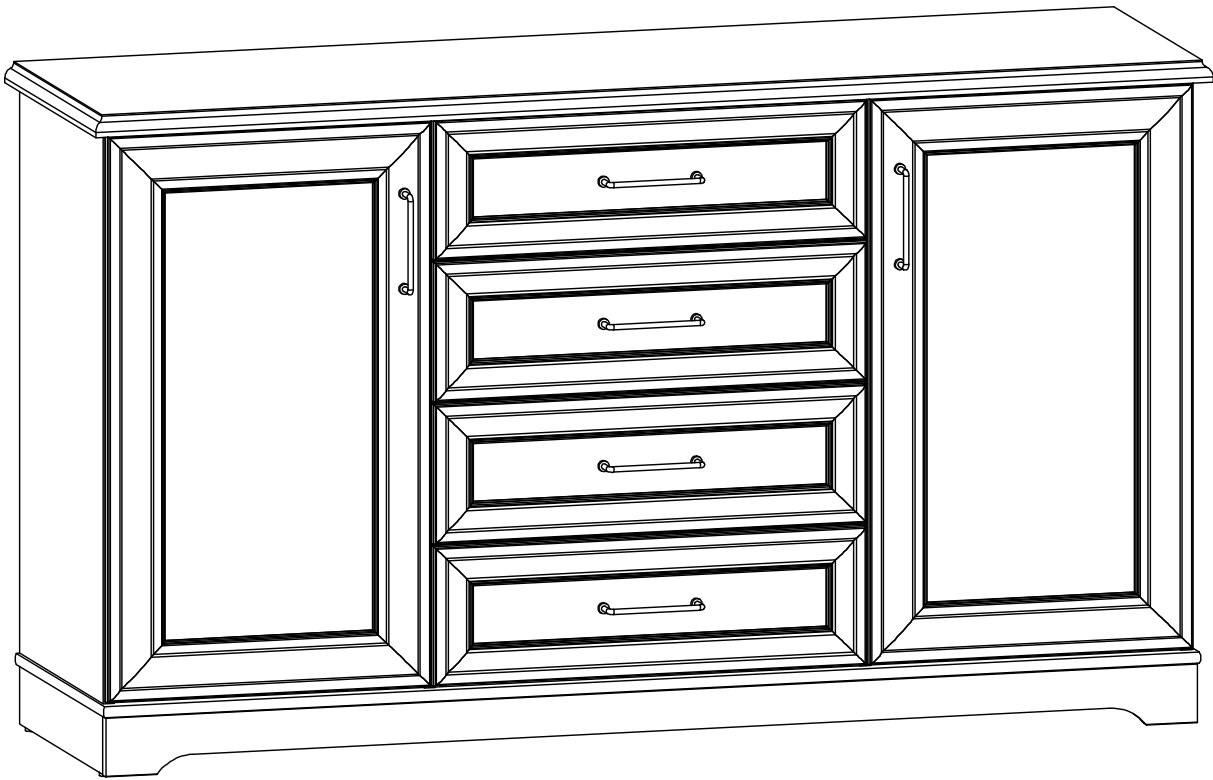
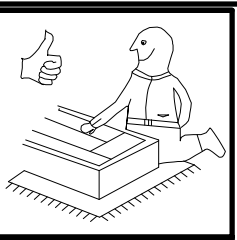
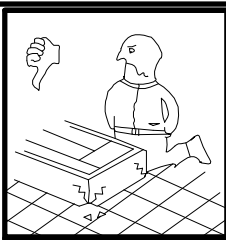
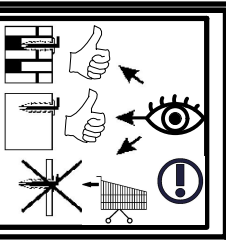
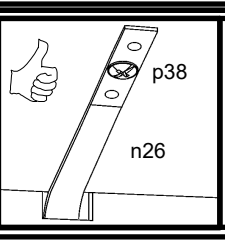
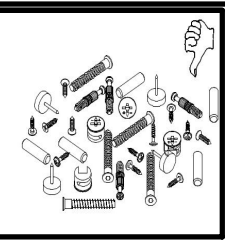
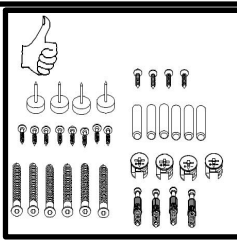
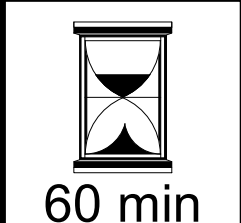
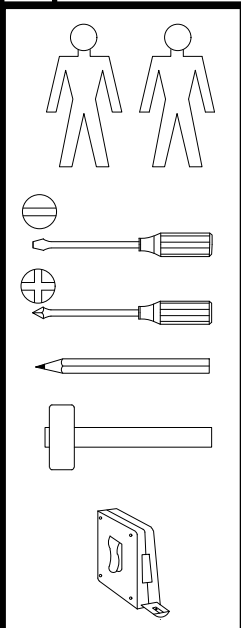
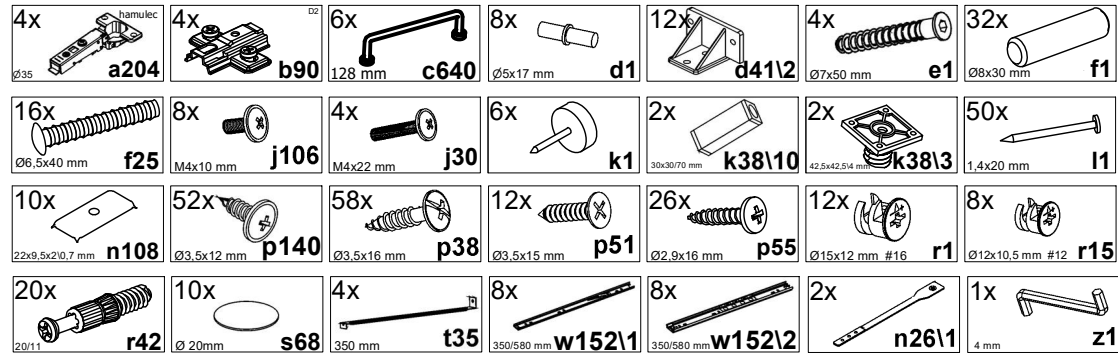
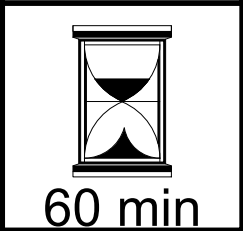
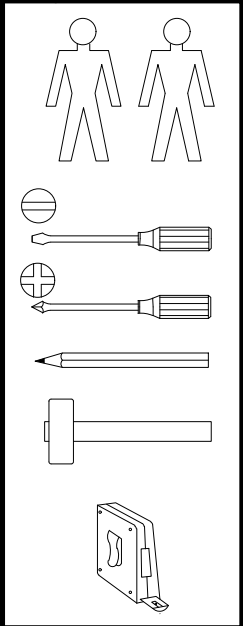
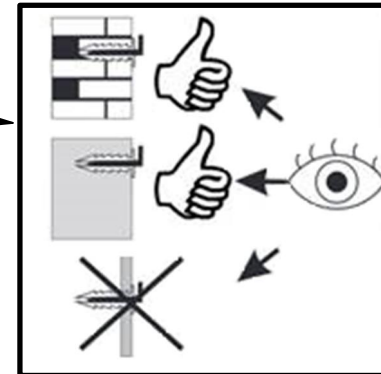
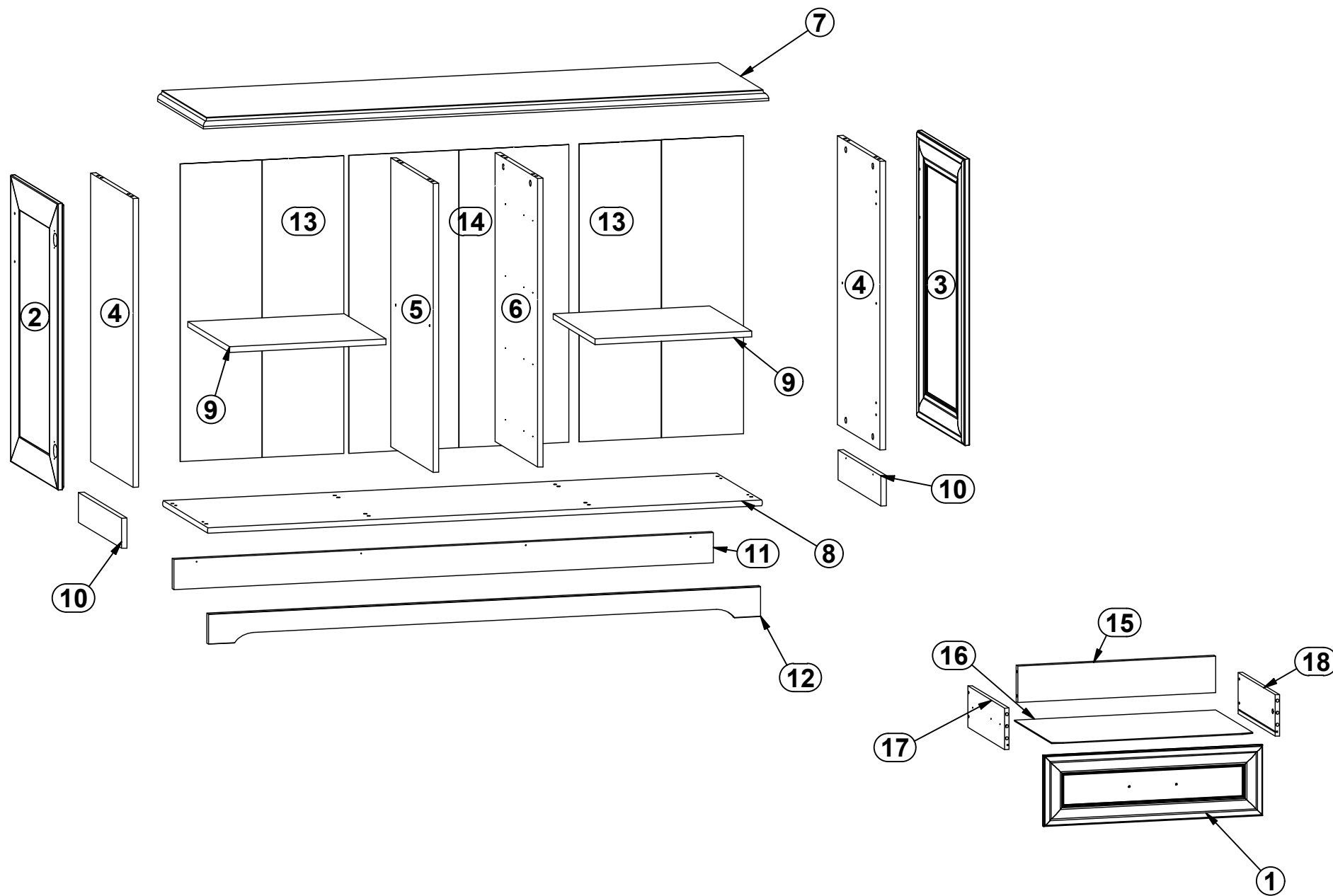

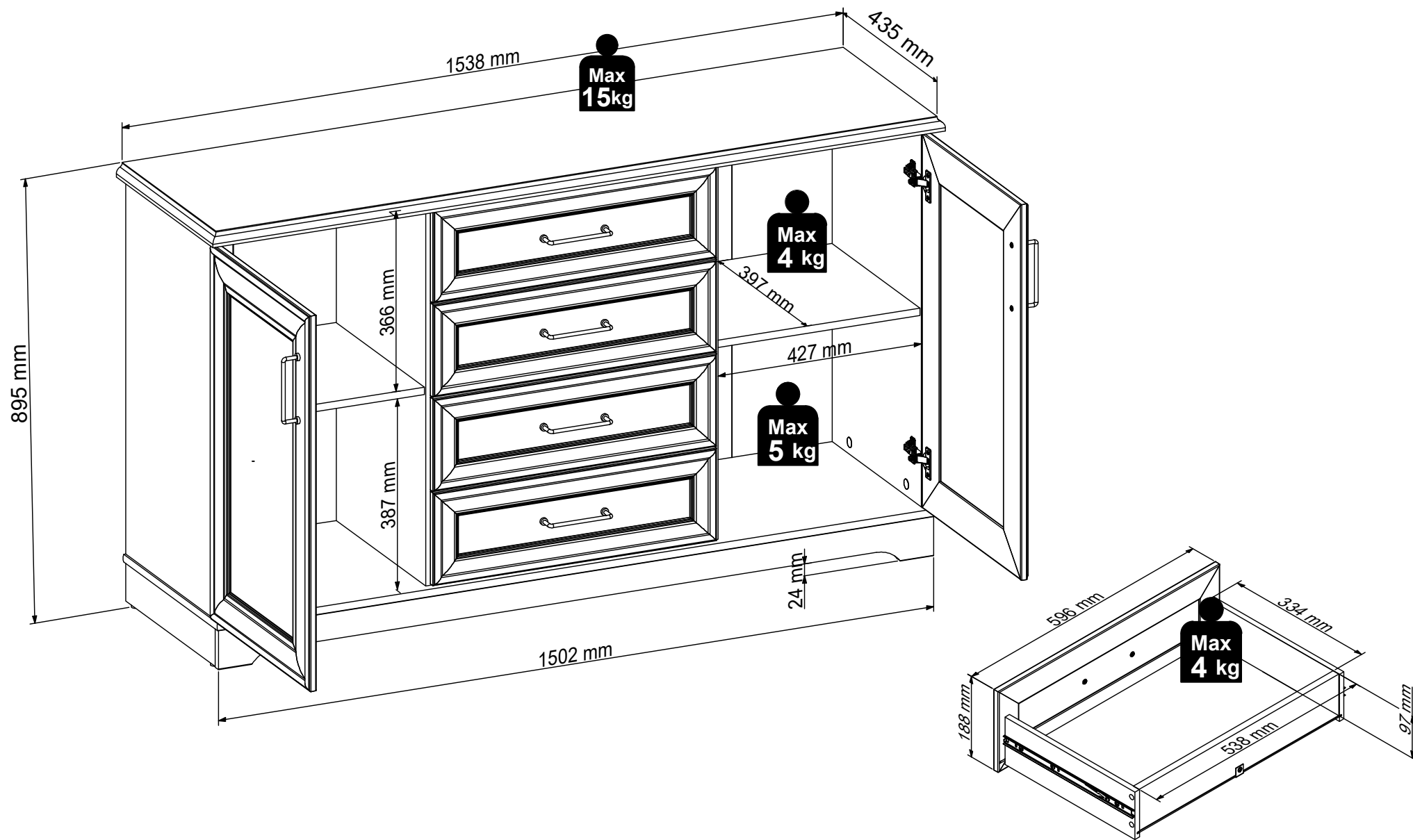
A	B1	B2	C1	C2	C3	D
1	S641-0003	-2	596	188	19	3/3
2	S641-0004	-2	761	446	19	3/3
3	S641-0005	-1	761	446	19	3/3
4	S641-1007	-4	767	402	15	1/3
5	S641-1008	-3	767	402	15	1/3
6	S641-1009	-2	767	402	15	1/3
7	S641-2006	-3	1538	435	28	2/3
8	S641-2007	-4	1510	424	15	2/3
9	S641-3002	-3	426	397	15	1/3
10	S641-4011	-3	406	80	15	1/3
11	S641-4013	-2	1468	80	15	2/3
12	S641-5003	-3	1502	80	15	2/3
13	S641-9302	-2	791	447	2,5	1/3
14	S641-9303	-2	791	599	2,5	1/3
15	STK-5040	-1	538	97	15	3/3
16	WDF-9099	-1	548	358	2,5	3/3
17	WSK2-5005	-5	350	110	12	3/3
18	WSK2-5006	-5	350	110	12	3/3

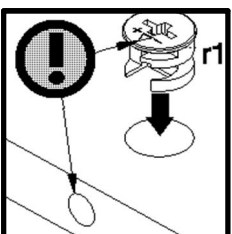
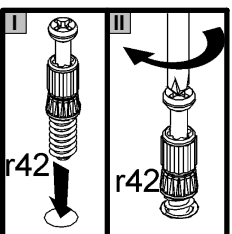
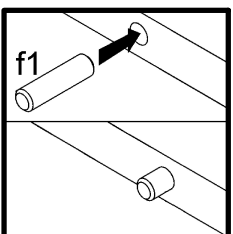
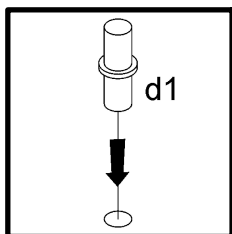
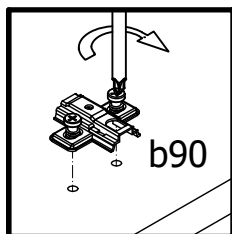
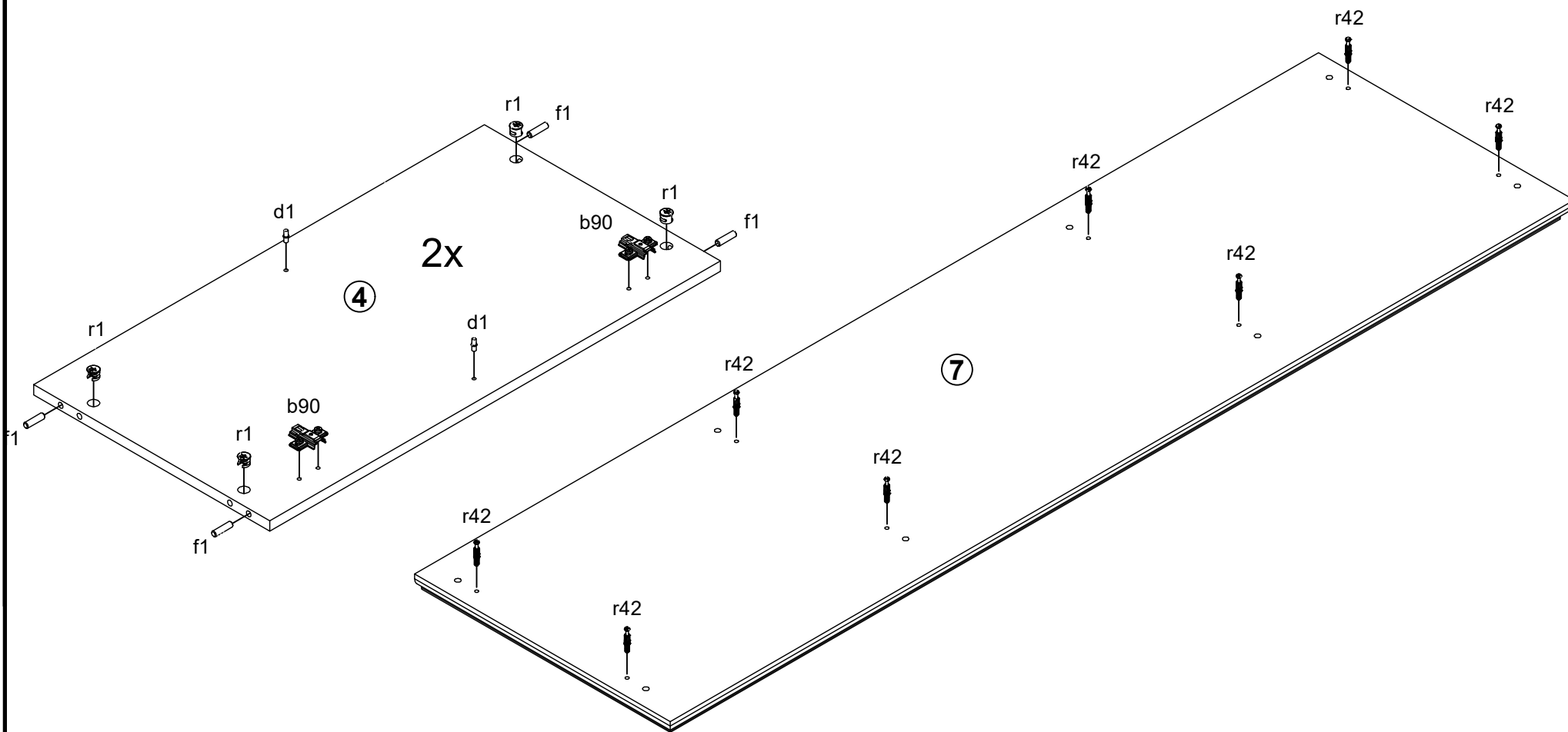
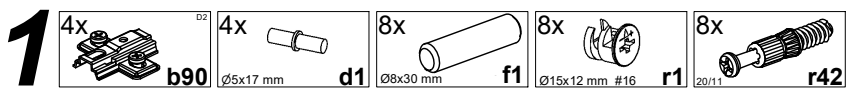







- 2** 2x  $\varnothing 5 \times 17$ mm **d1**
- 4x  $\varnothing 8 \times 30$ mm **f1**
- 12x  $\varnothing 3.5 \times 12$ mm **p140**
- 2x  $\varnothing 15 \times 12$ mm #16 **r1**
- 4x  $350/580$ mm **w152/2**

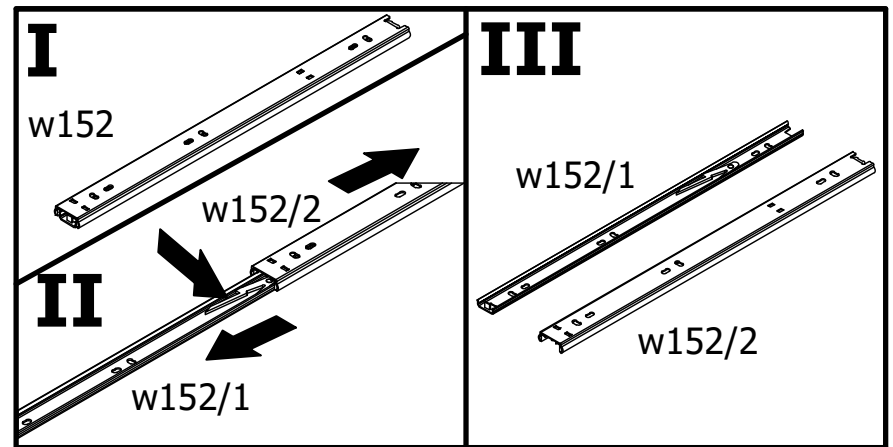
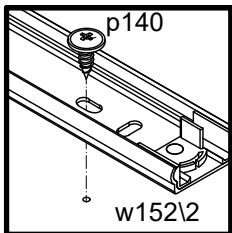
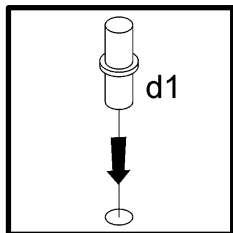
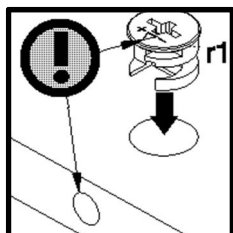
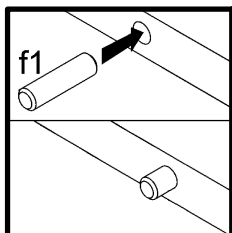
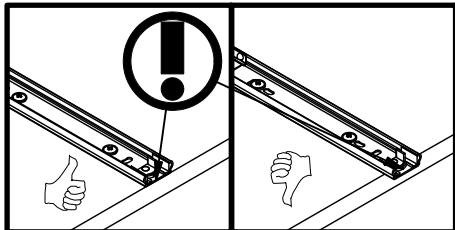
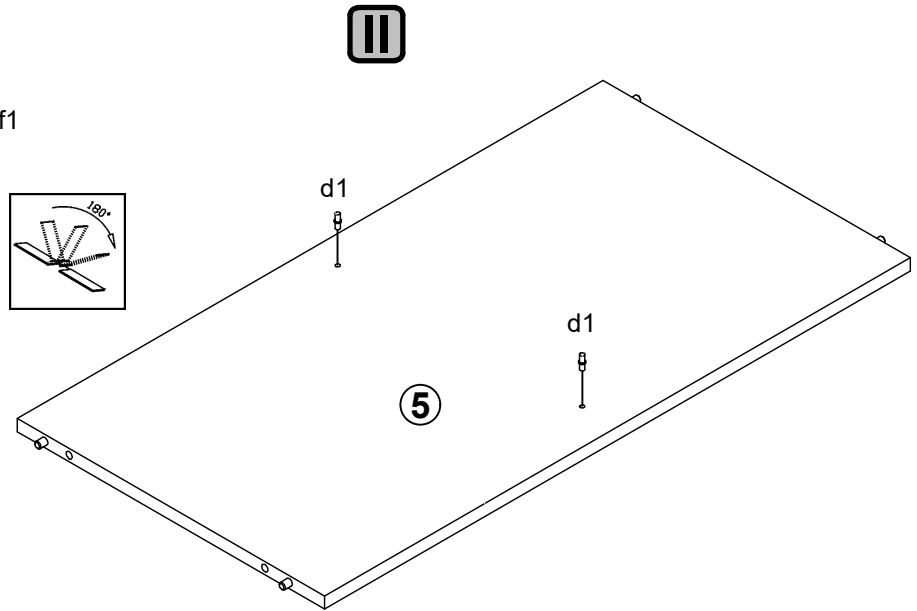
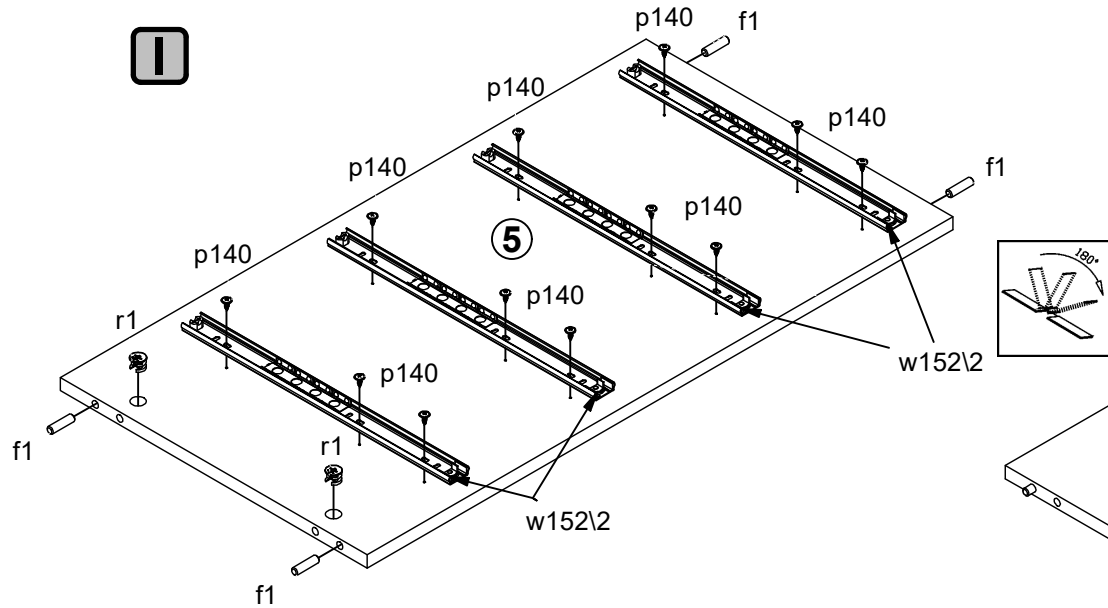

- 3 2x $\varnothing 5 \times 17$ mm d1
- 4x $\varnothing 8 \times 30$ mm f1
- 12x $\varnothing 3.5 \times 12$ mm p140
- 2x $\varnothing 15 \times 12$ mm #16 r1
- 4x 350/580 mm w152\2

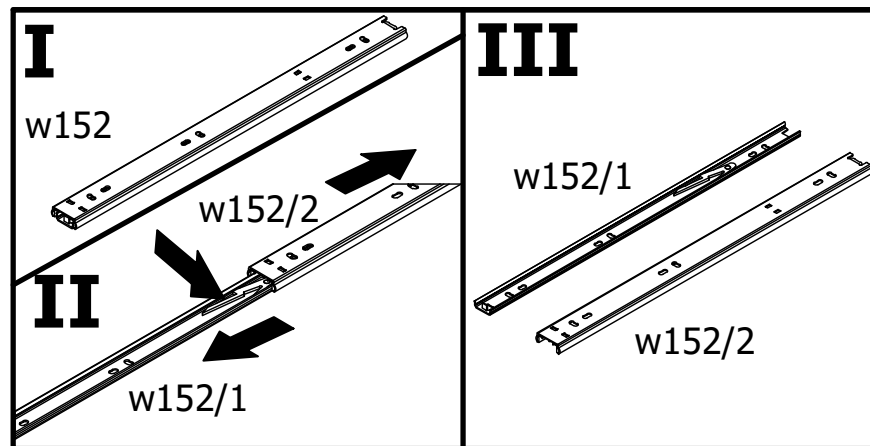
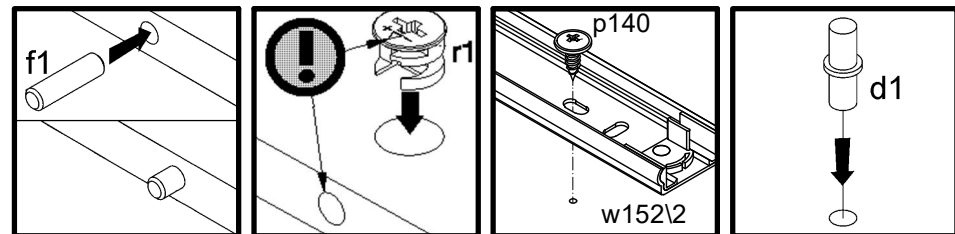
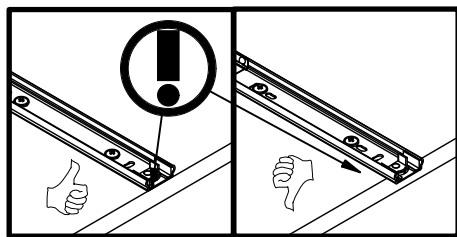
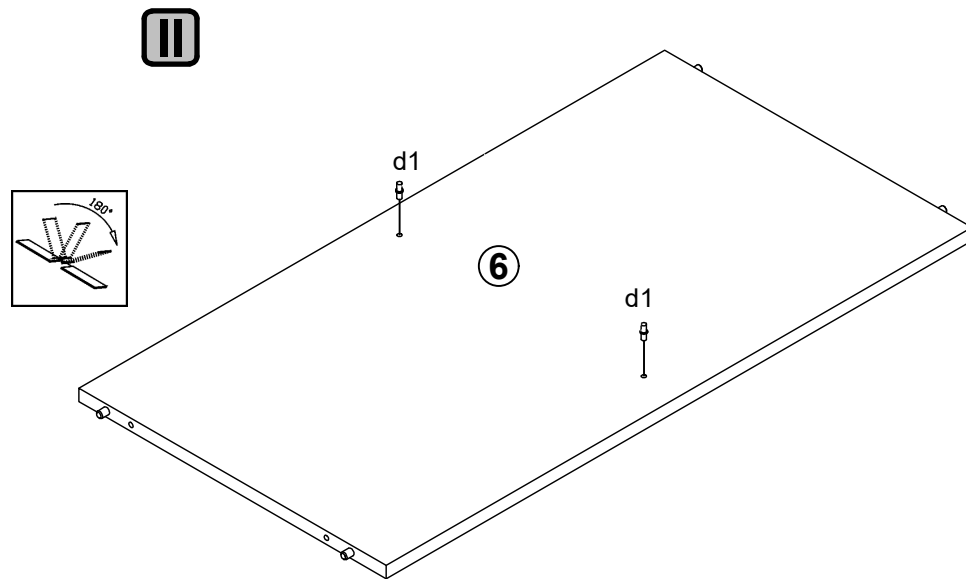
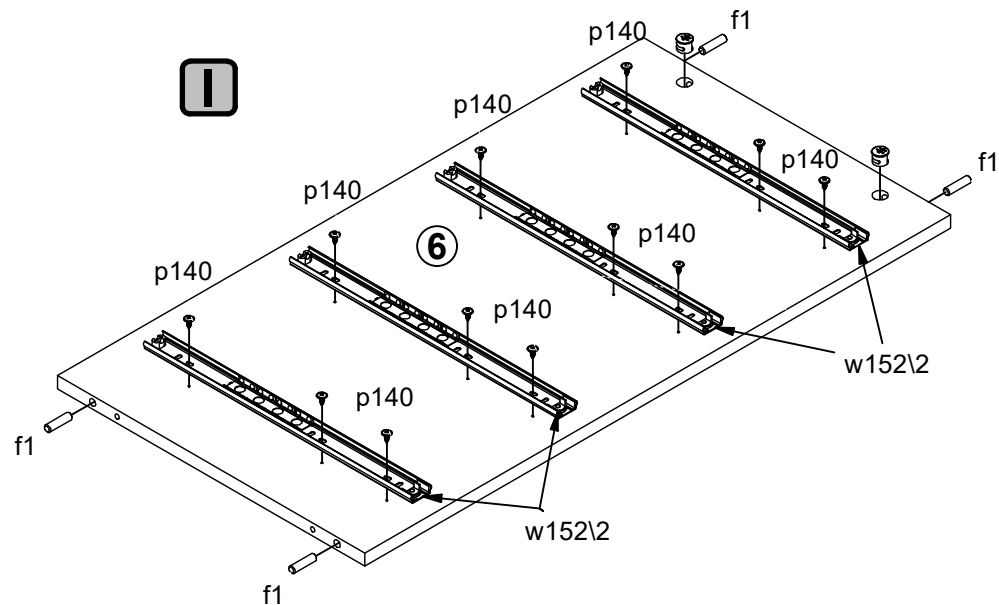

4

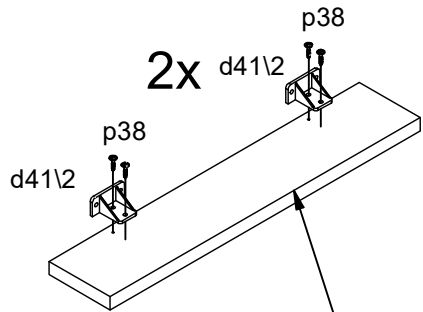
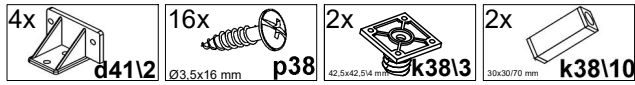

10

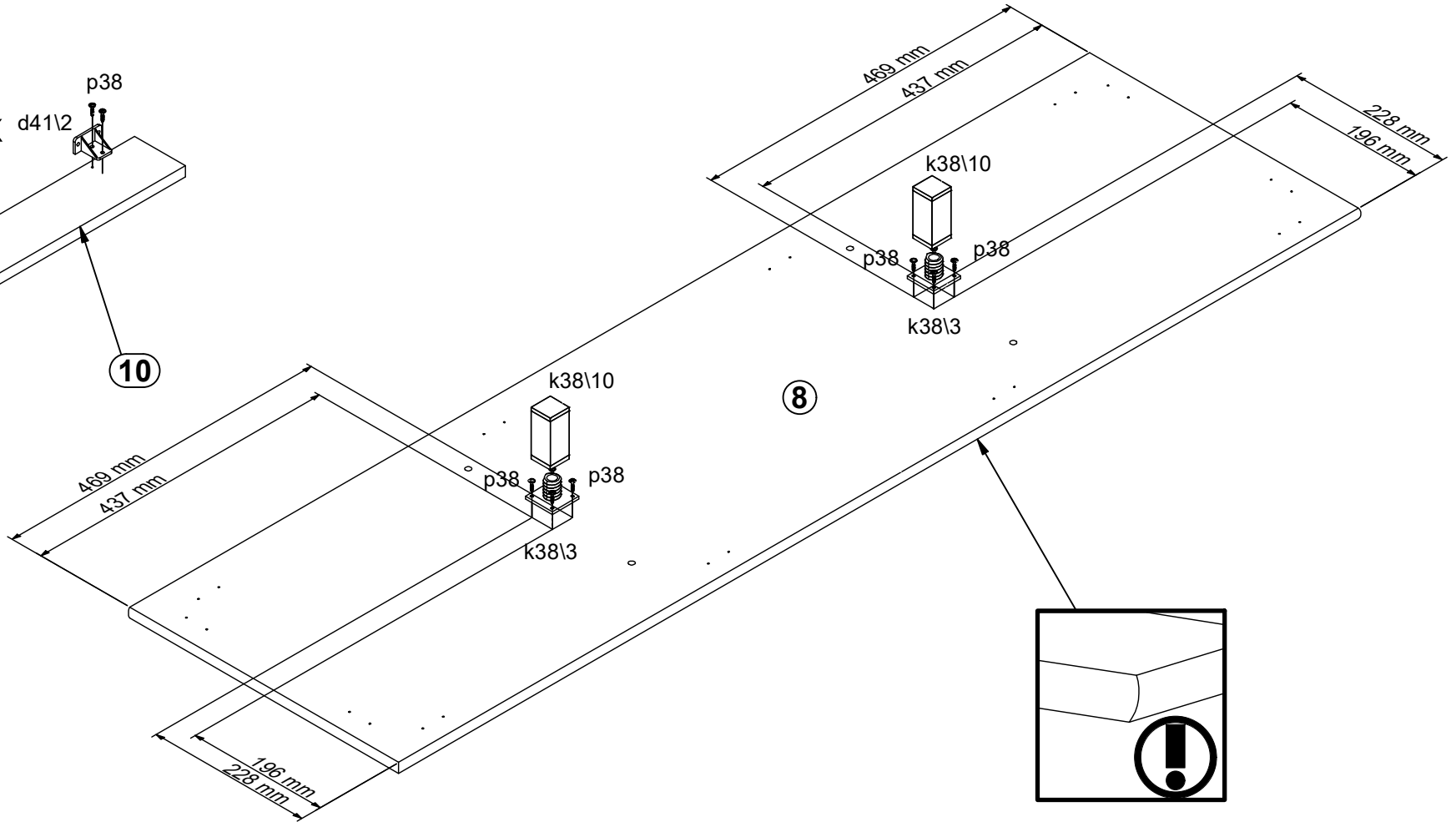

8

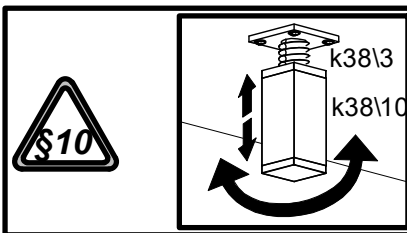
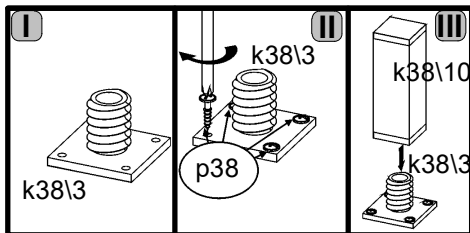
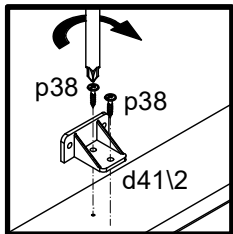

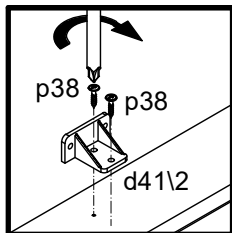
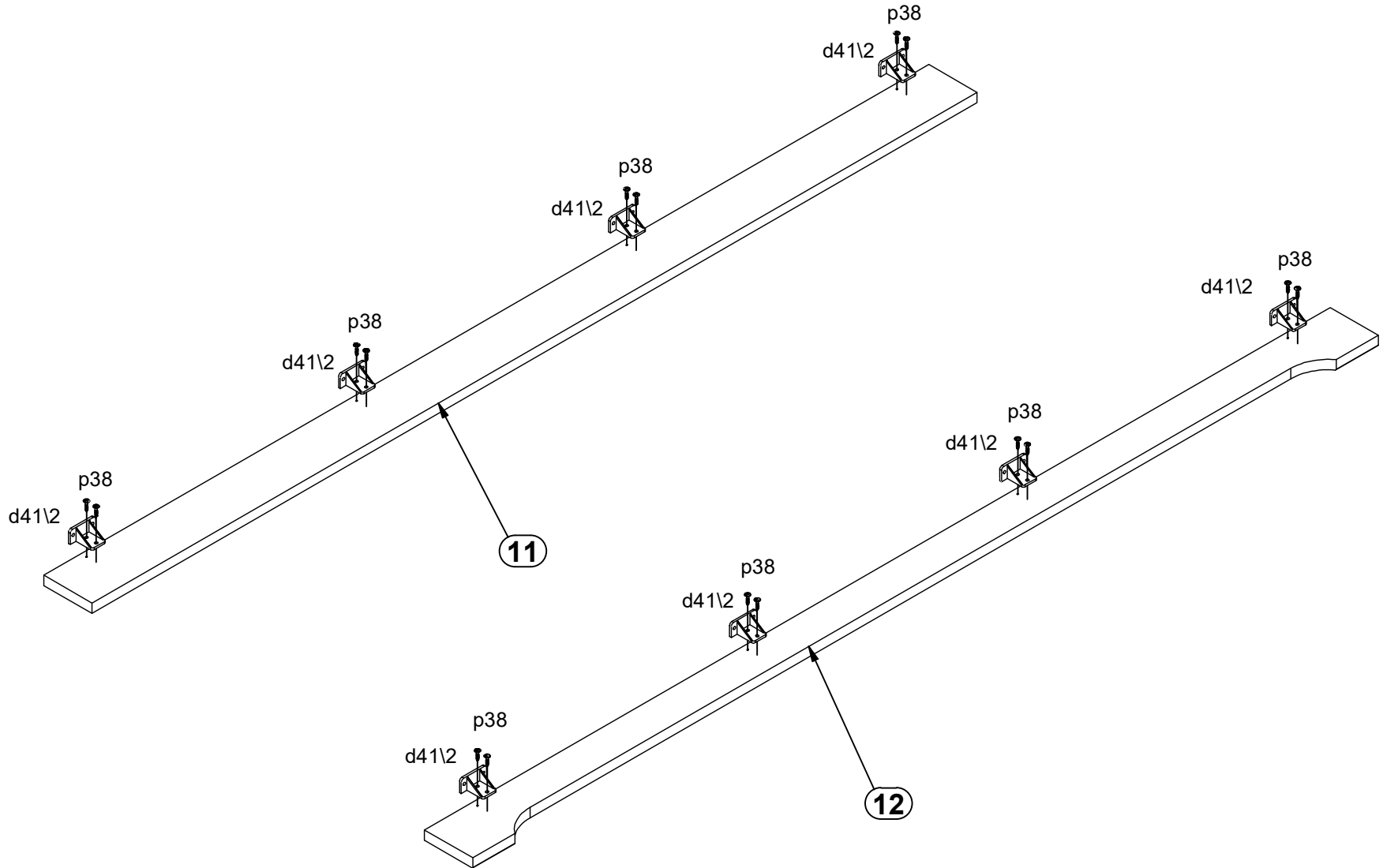
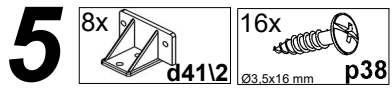

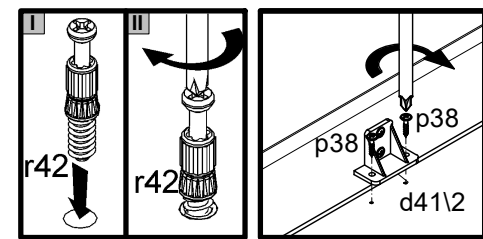
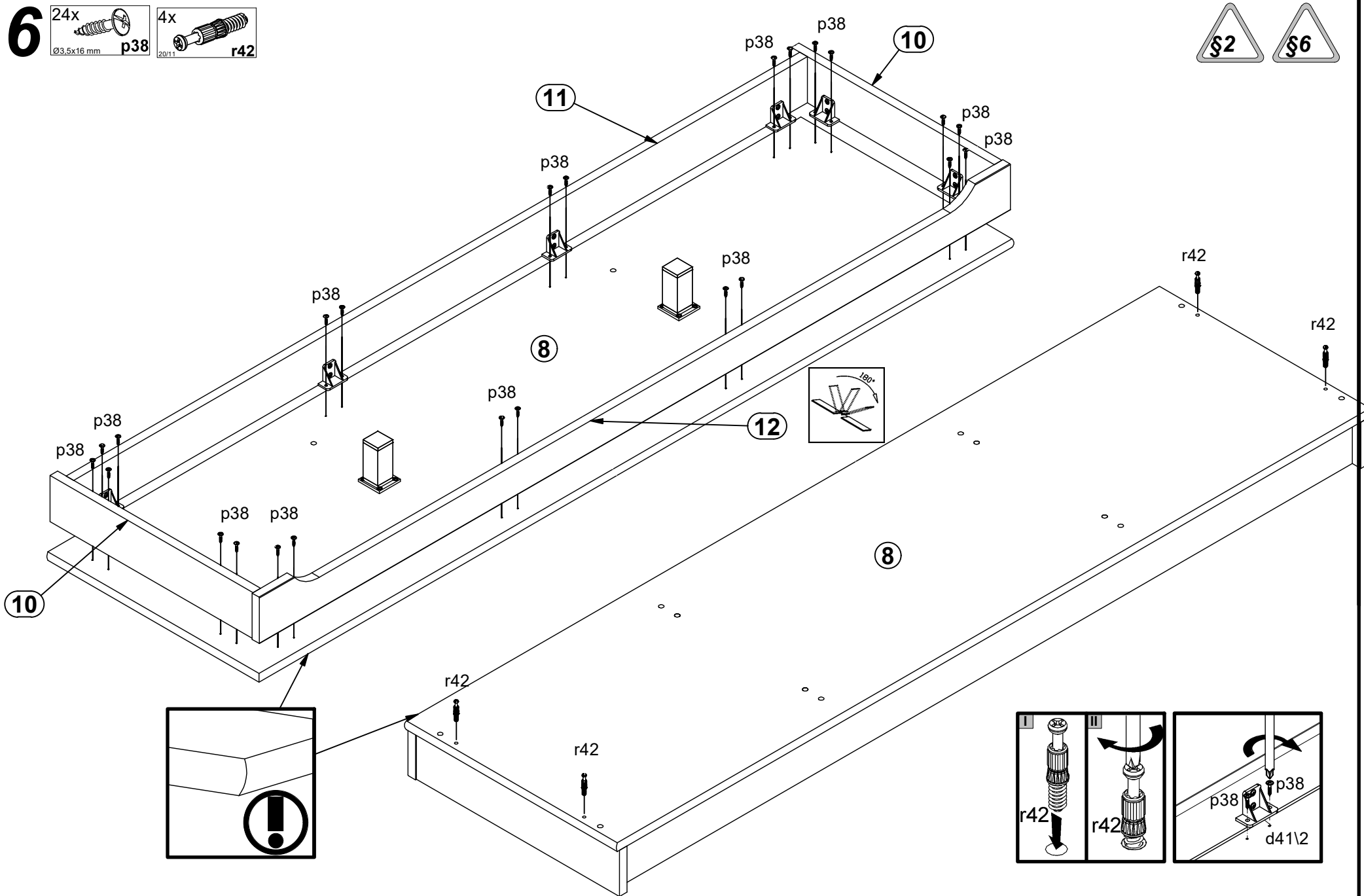
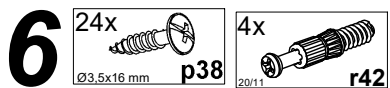

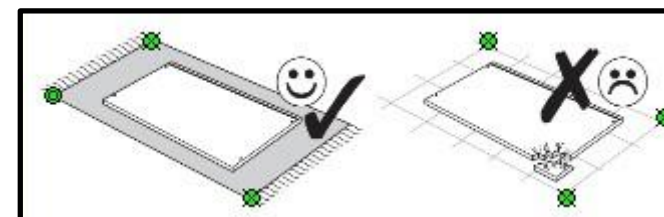
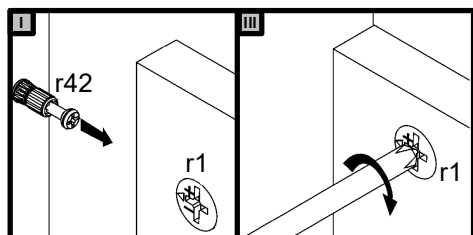
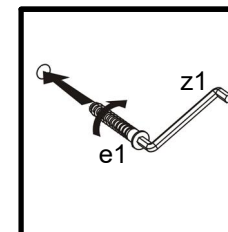
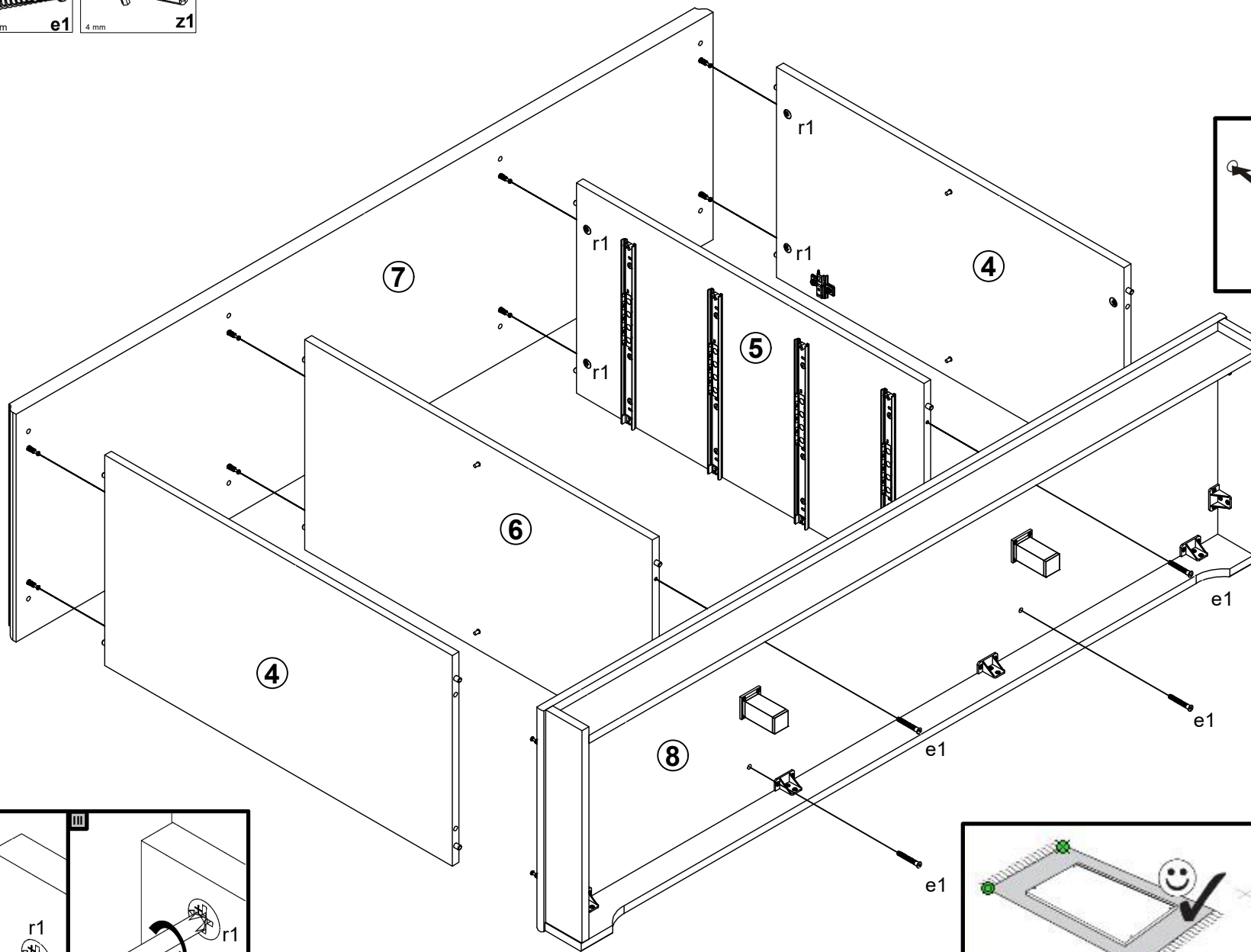
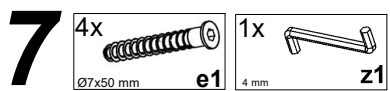



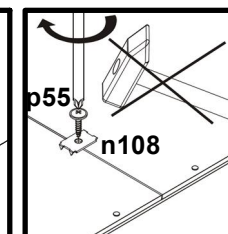
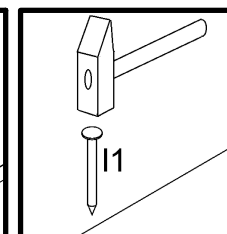
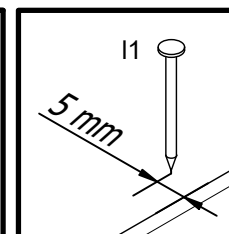
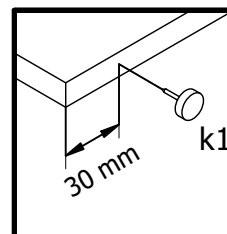
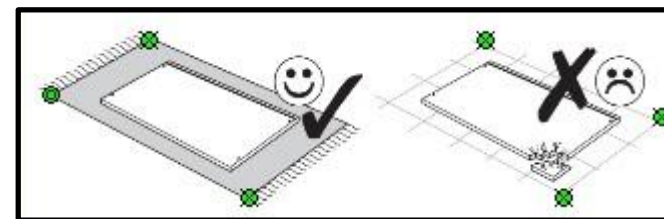
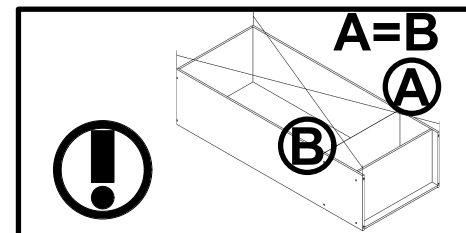
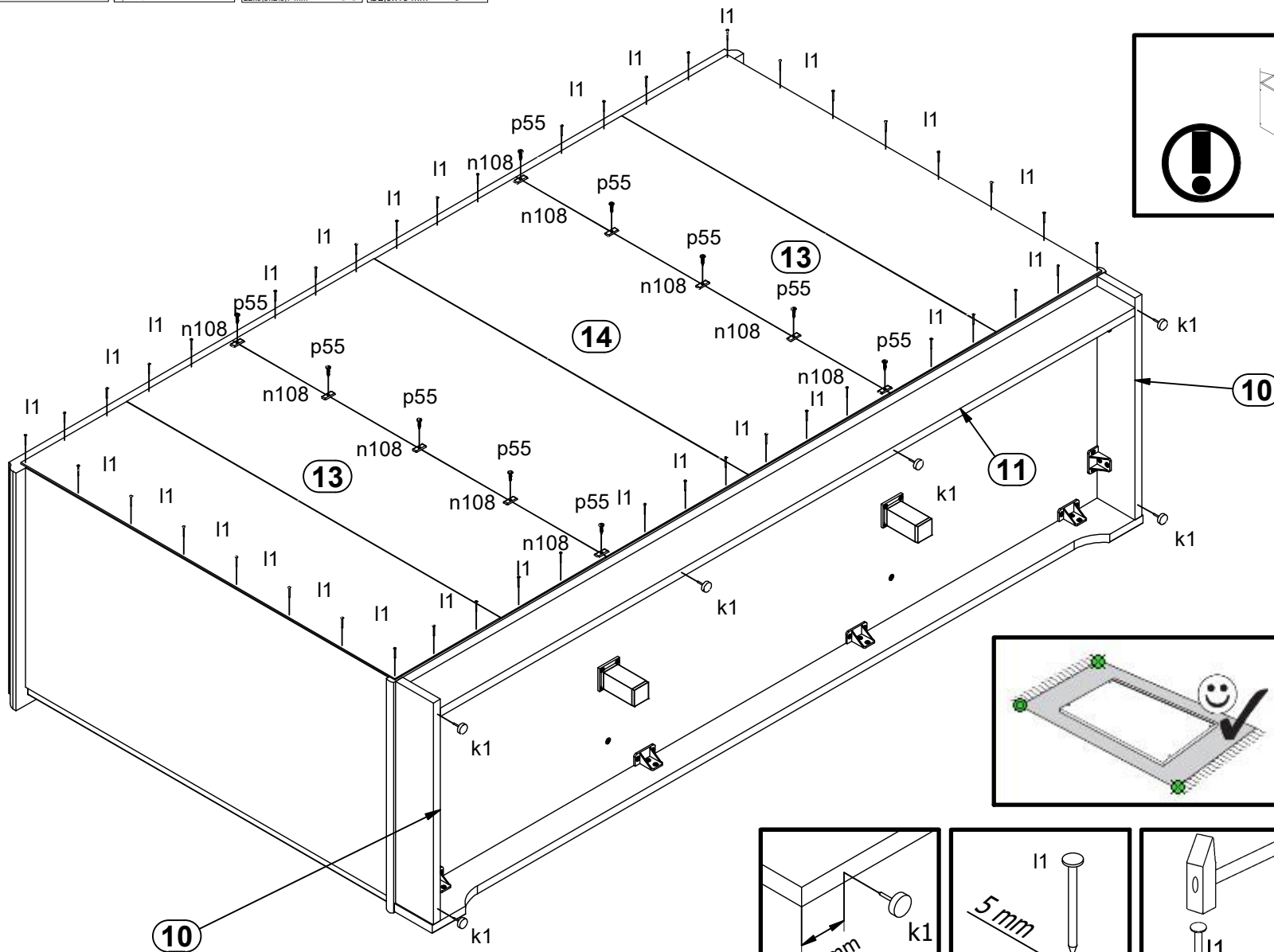
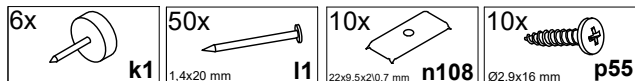

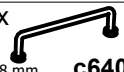
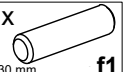
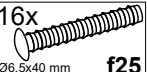

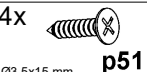
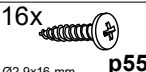
8

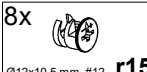
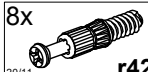
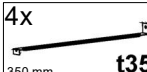



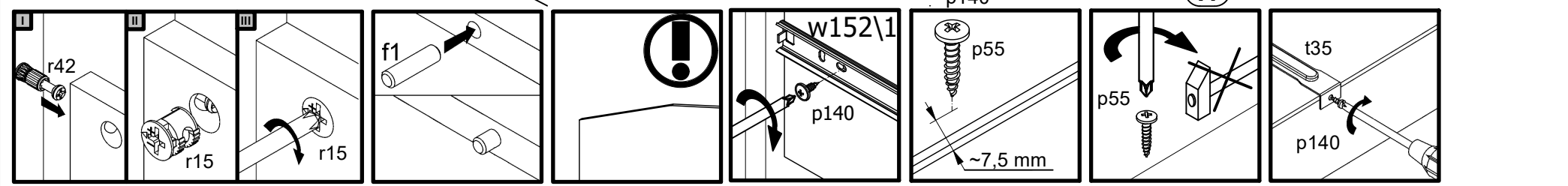
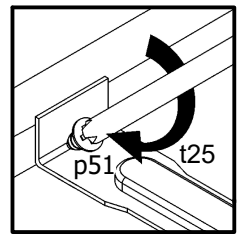
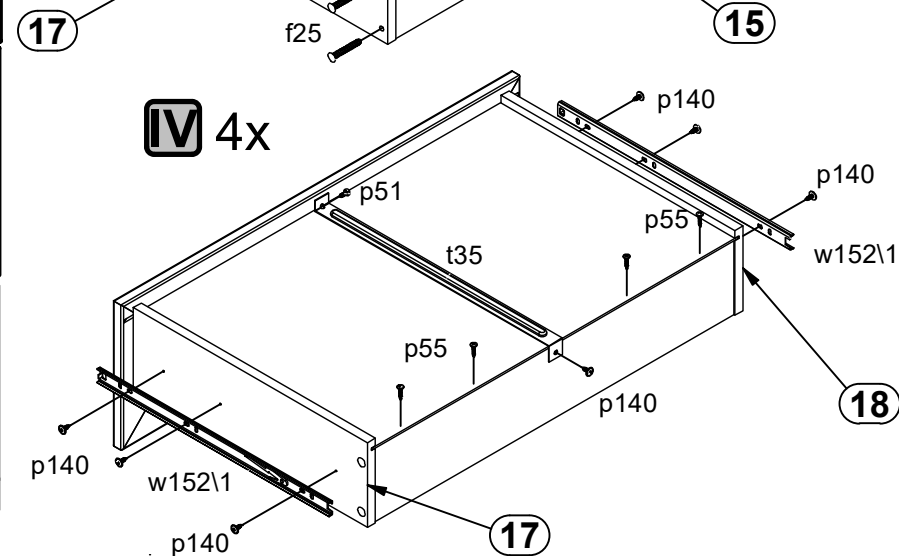
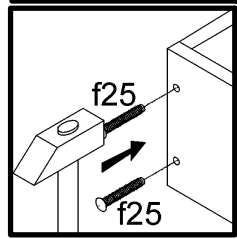
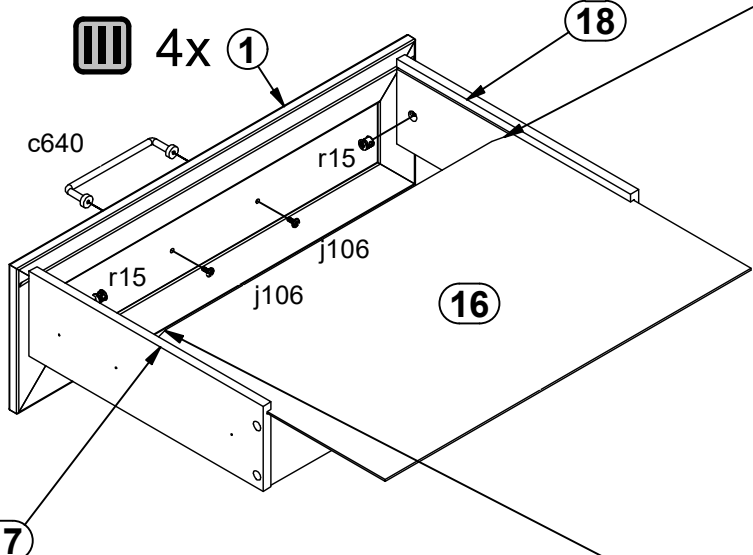
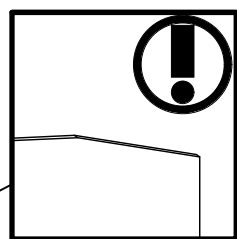
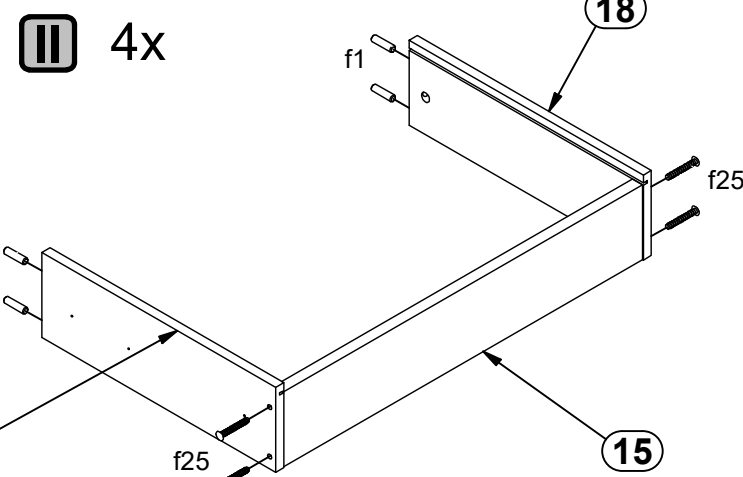
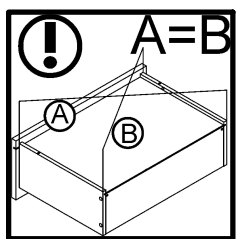
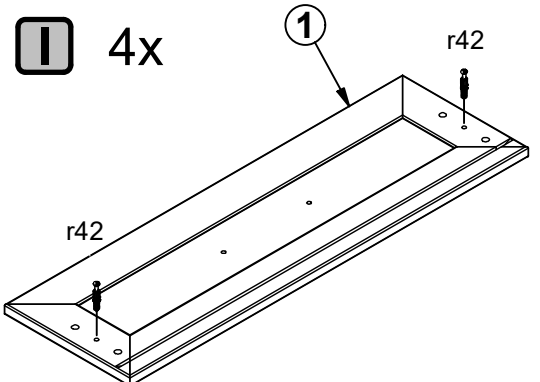

- 9** 4x  **c640**
128 mm
- 16x  **f1**
Ø8x30 mm
- 16x  **f25**
Ø6,5x40 mm
- 8x  **j106**
M4x10 mm
- 4x  **p51**
Ø3,5x15 mm
- 16x  **p55**
Ø2,9x16 mm
- 28x  **p140**
Ø3,5x12 mm
- 8x  **r15**
Ø12x10,5 mm #12
- 8x  **r42**
20/11
- 4x  **t35**
350 mm
- 8x  **w152\1**
350/580 mm

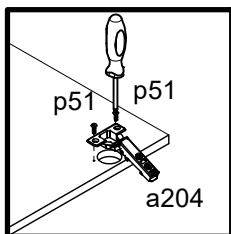
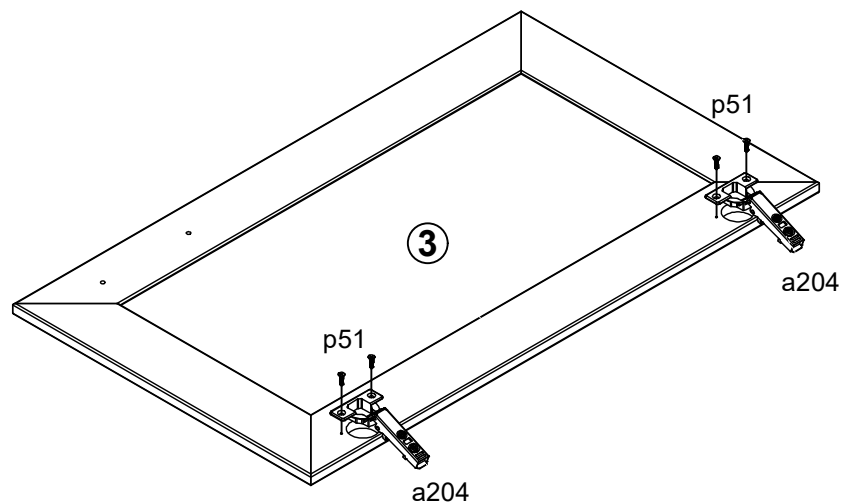
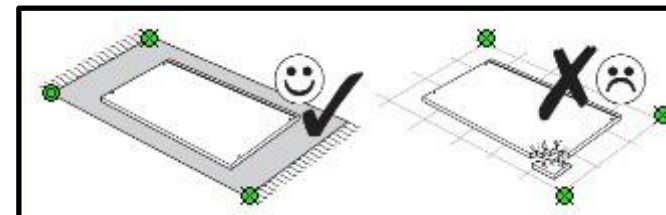
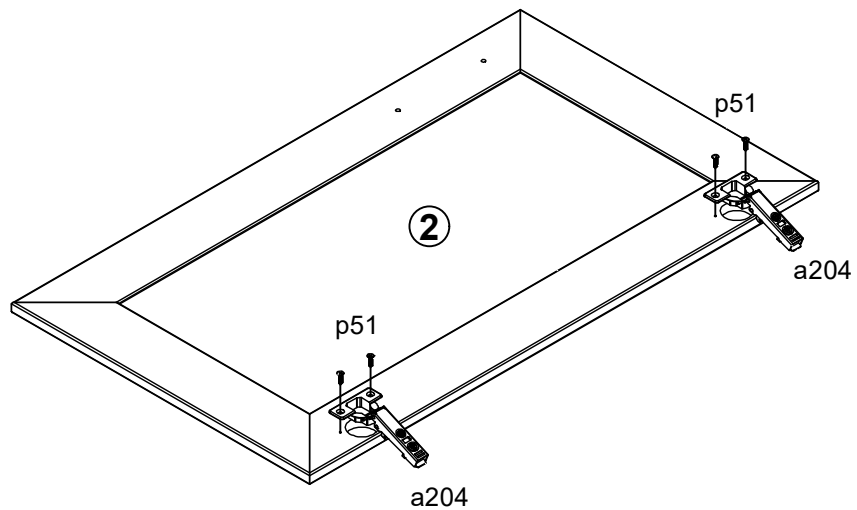
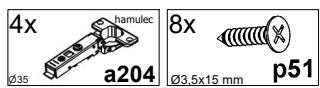

10

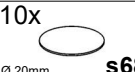

- 11**
- 2x  128 mm **c640**
 - 4x  M4x22 mm **j30**
 - 2x  **n26\1**
 - 2x  Ø3,5x16 mm **p38**
 - 10x  Ø 20mm **s68**

