

A	B	C1	C2	C3	D
1	S504-0029	1418,	396	16	3/3
2	S504-1040	1392	390	15	2/3
3	S504-1041	1392	390	15	2/3
4	S504-1042	1392	364,	15	2/3
5	S504-2023	900	390	15	1/3
6	S504-2024	900	390	15	1/3
7	S504-3006	476	360	15	1/3
8	S504-3008	470	340	4	1/3
9	S504-3014	477	360	15	1/3
10	S504-3015	376	360	15	1/3
11	S504-5556	469,	480	3,	3/3
12	S504-5703	370	100	6,	3/3
13	S504-5711	270	100	6,	3/3
14	S504-7317	809,	496	16	3/3
15	S504-7319	200	496	16	3/3
16	S504-9006	1402	390	2,5	2/3
17	S504-9307	1402	489,	2,5	2/3
18	qc33\1				1/3
19	S504-7353	270	100	6,	3/3
20	S504-7354	370	100	6,	3/3

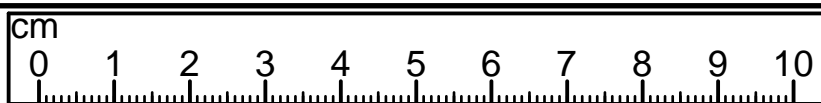

6x a102	6x H2 b59	16x Ø5x17 mm d1	4x d38	6x Ø7x50 mm e1	6x Ø5x16 mm e47	20x Ø8x30 mm f1	5x k27	15x l1	14x l2	6x 20x13x3,5\1 n108	6x Ø5,3xØ8,3x4,8 mm o54	8x Ø3,5x16 mm p38
12x Ø3,5x15 mm p51	6x Ø2,9x16 mm p55	14x Ø15x12 mm #16 r1	14x r42	14x Ø16 s2	1x z1							
1x Ø10x50 mm f35	1x 86x21x15\1,5 n14\2	1x Ø5x60 mm p17	2x Ø3,5x16 mm p38									

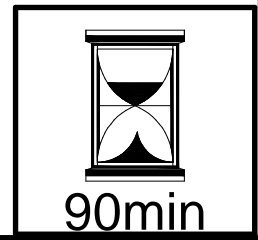
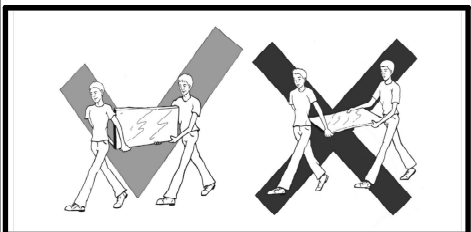
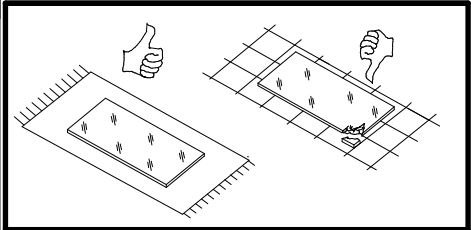
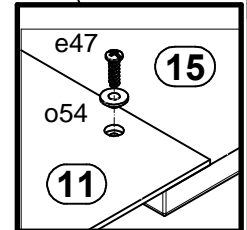
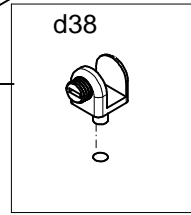
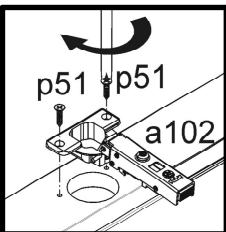
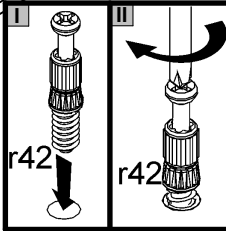
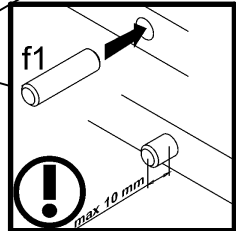
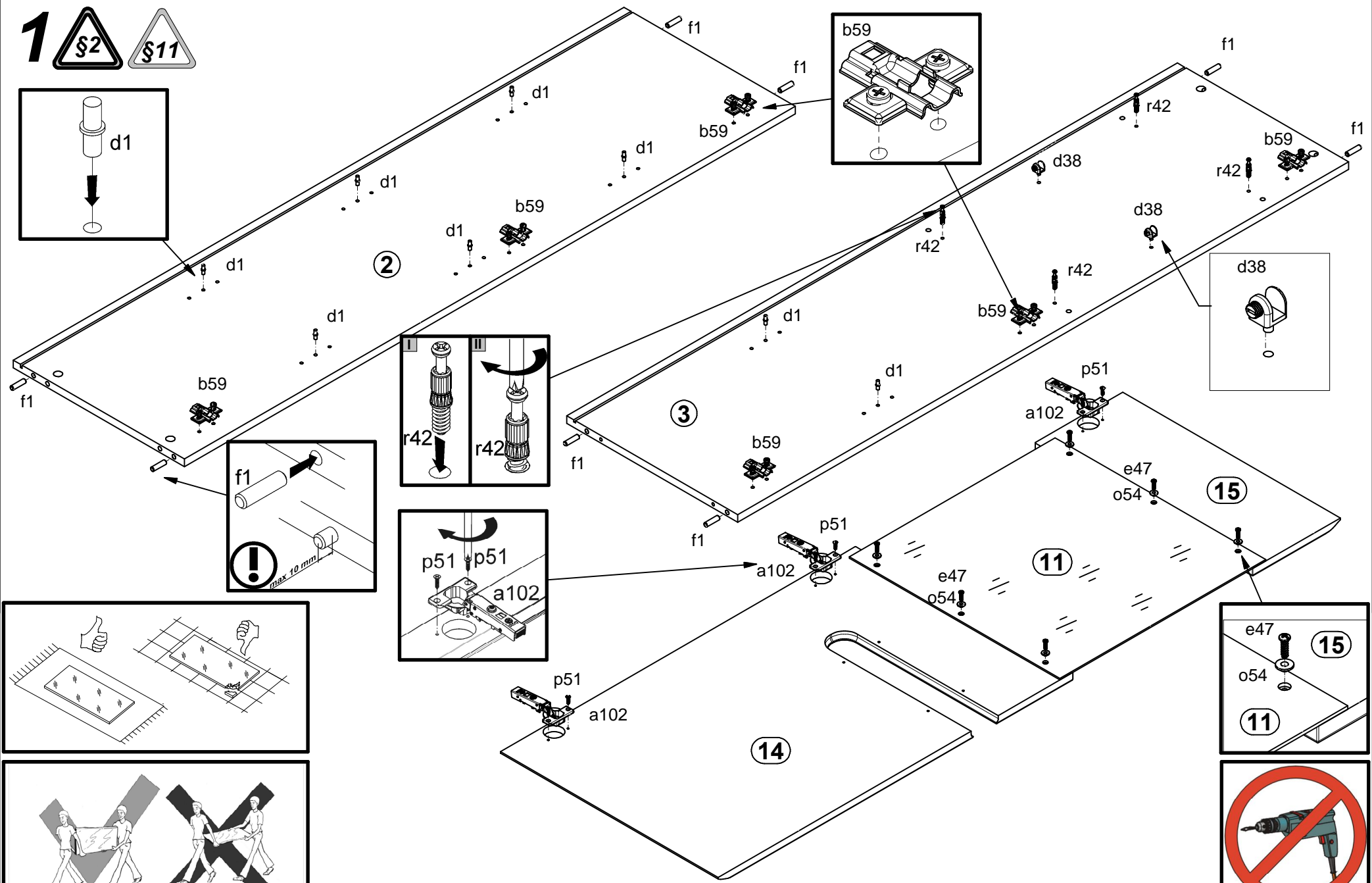
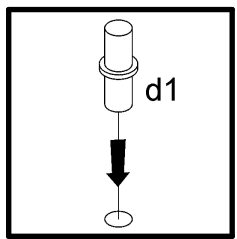

2

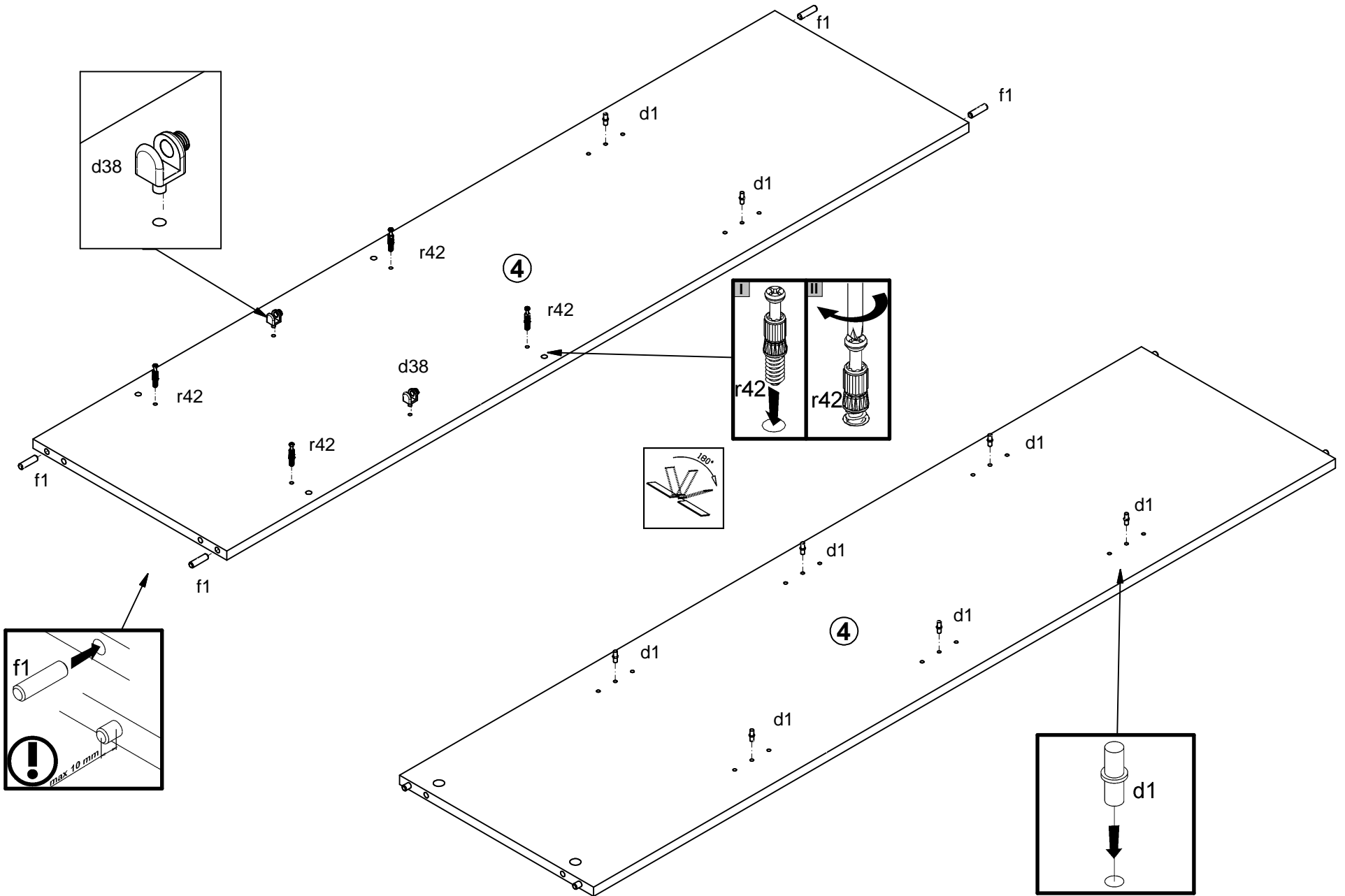

3

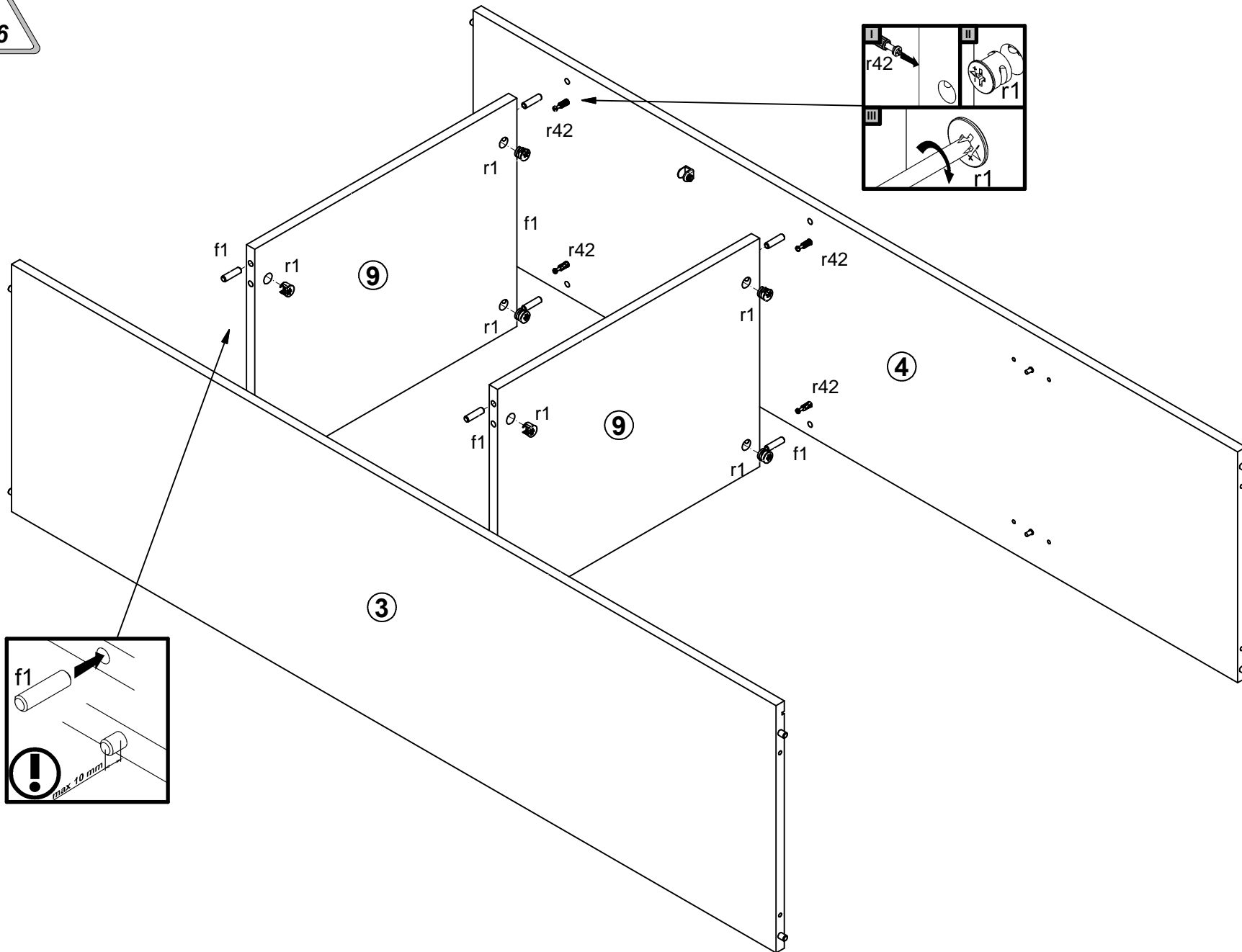

4

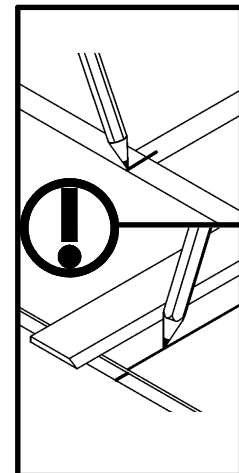
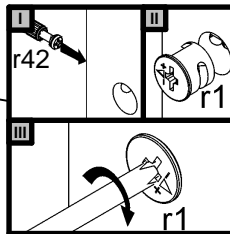
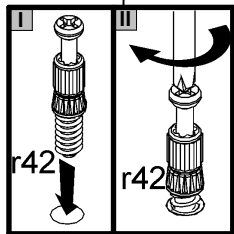
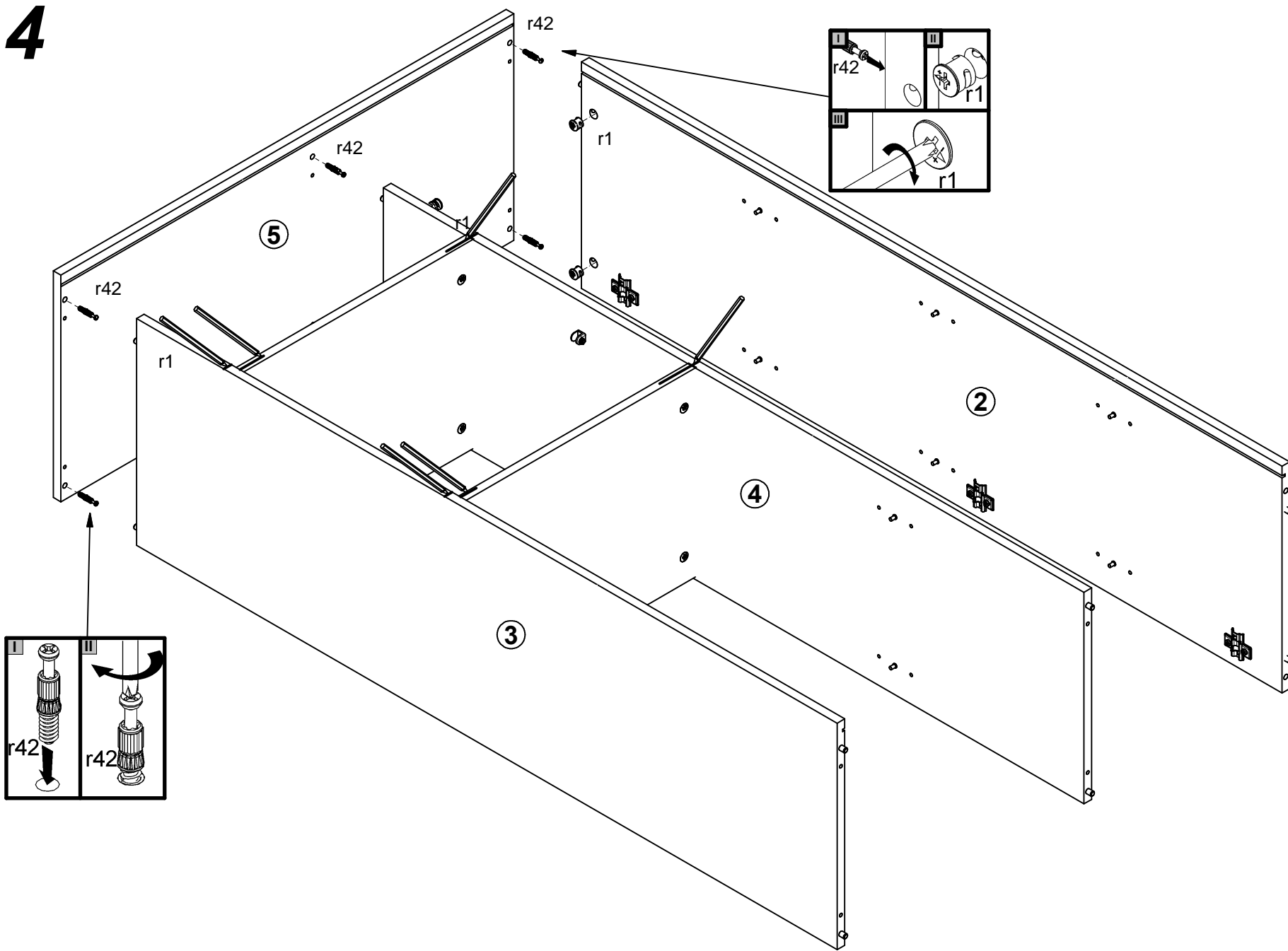

5

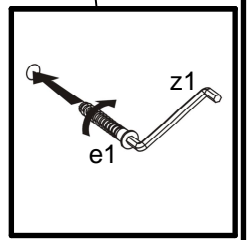
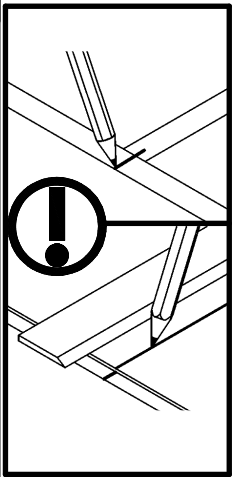
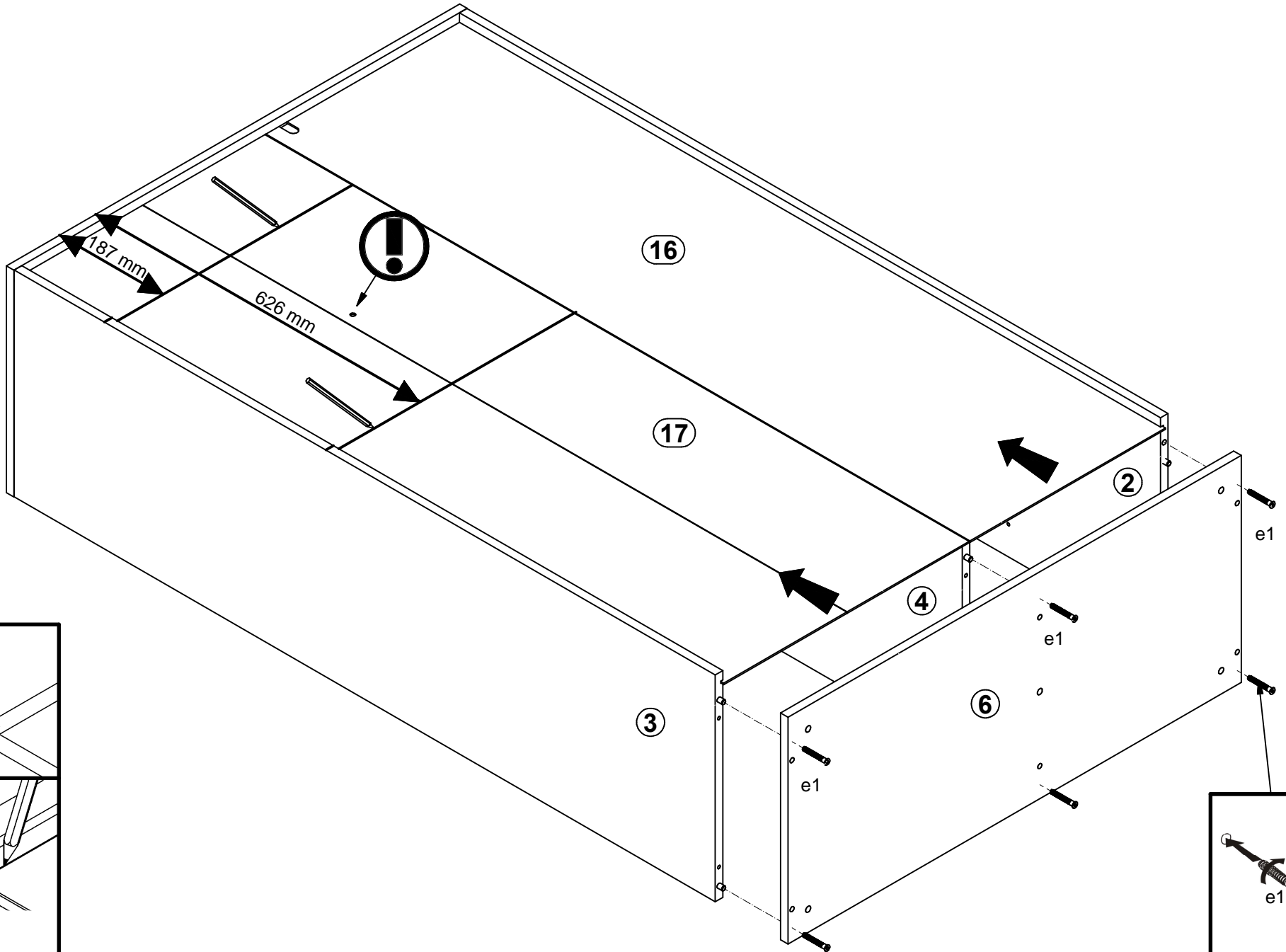

6

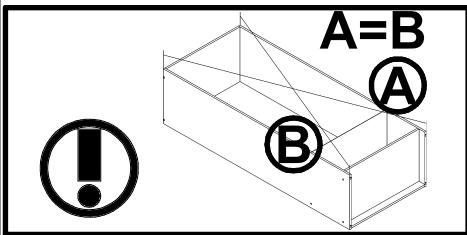
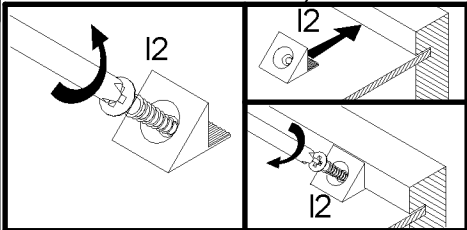
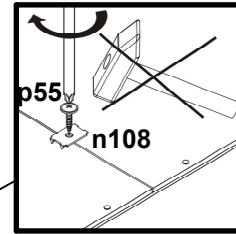
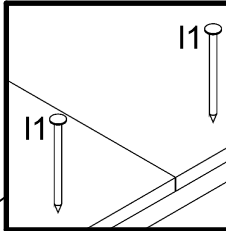
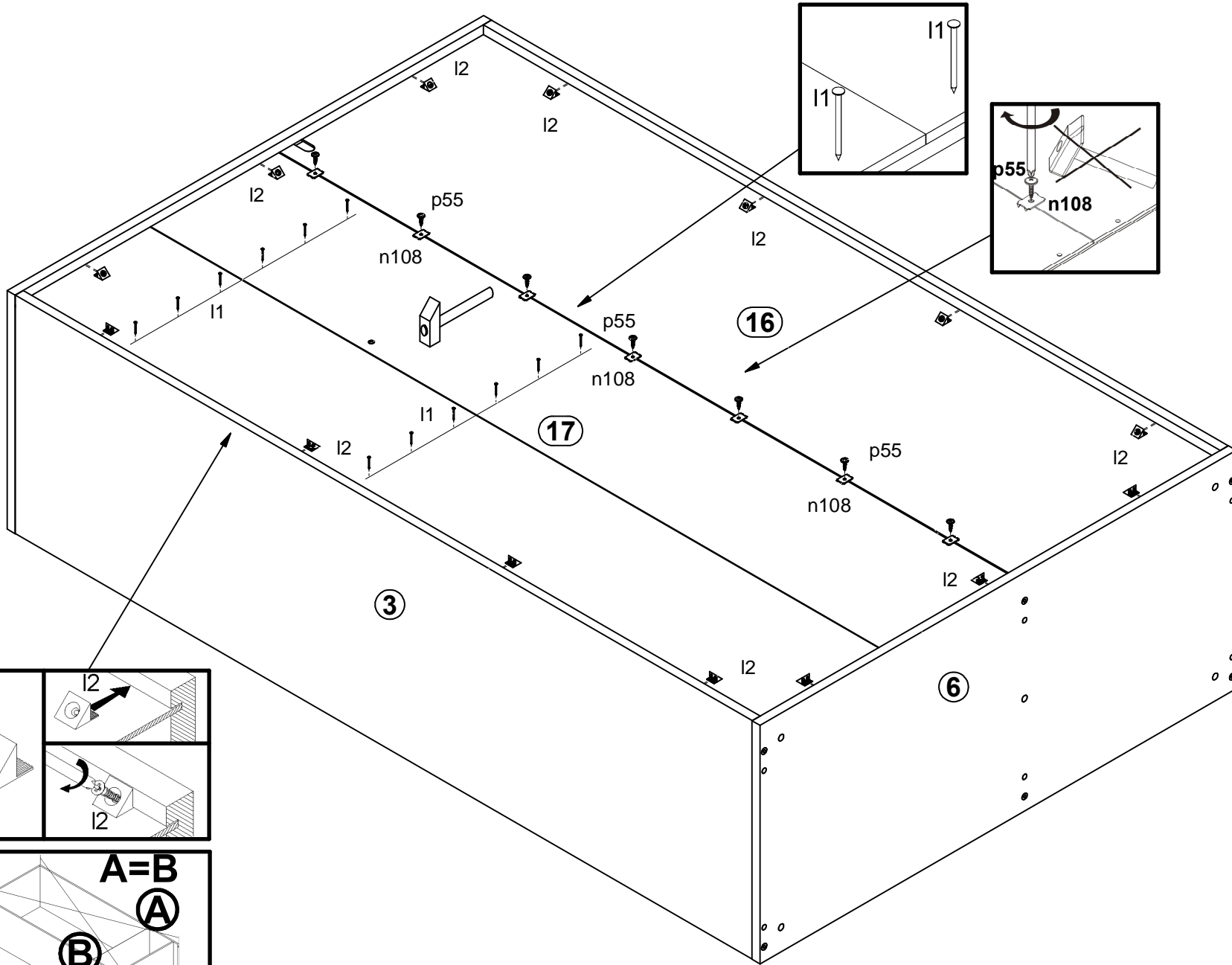

6

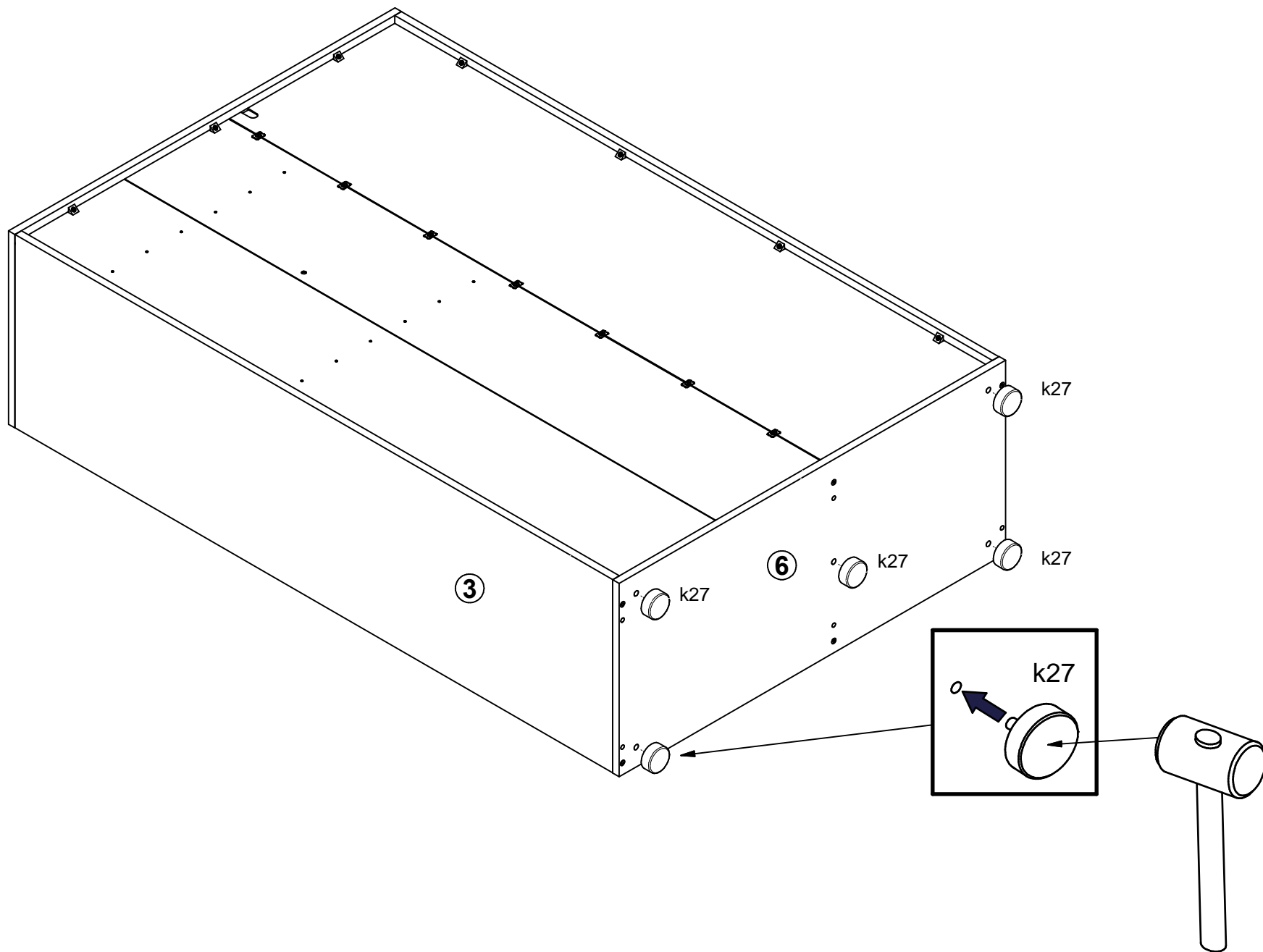

7

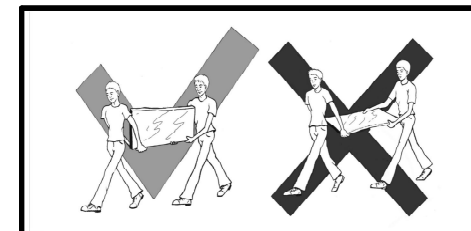
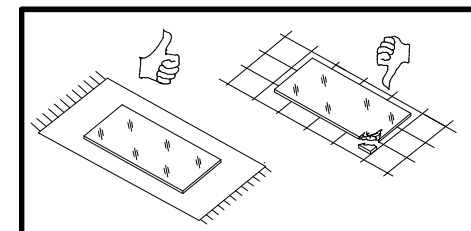
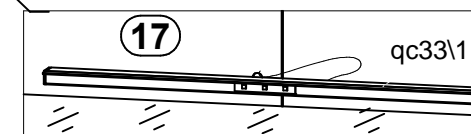
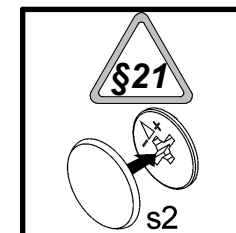
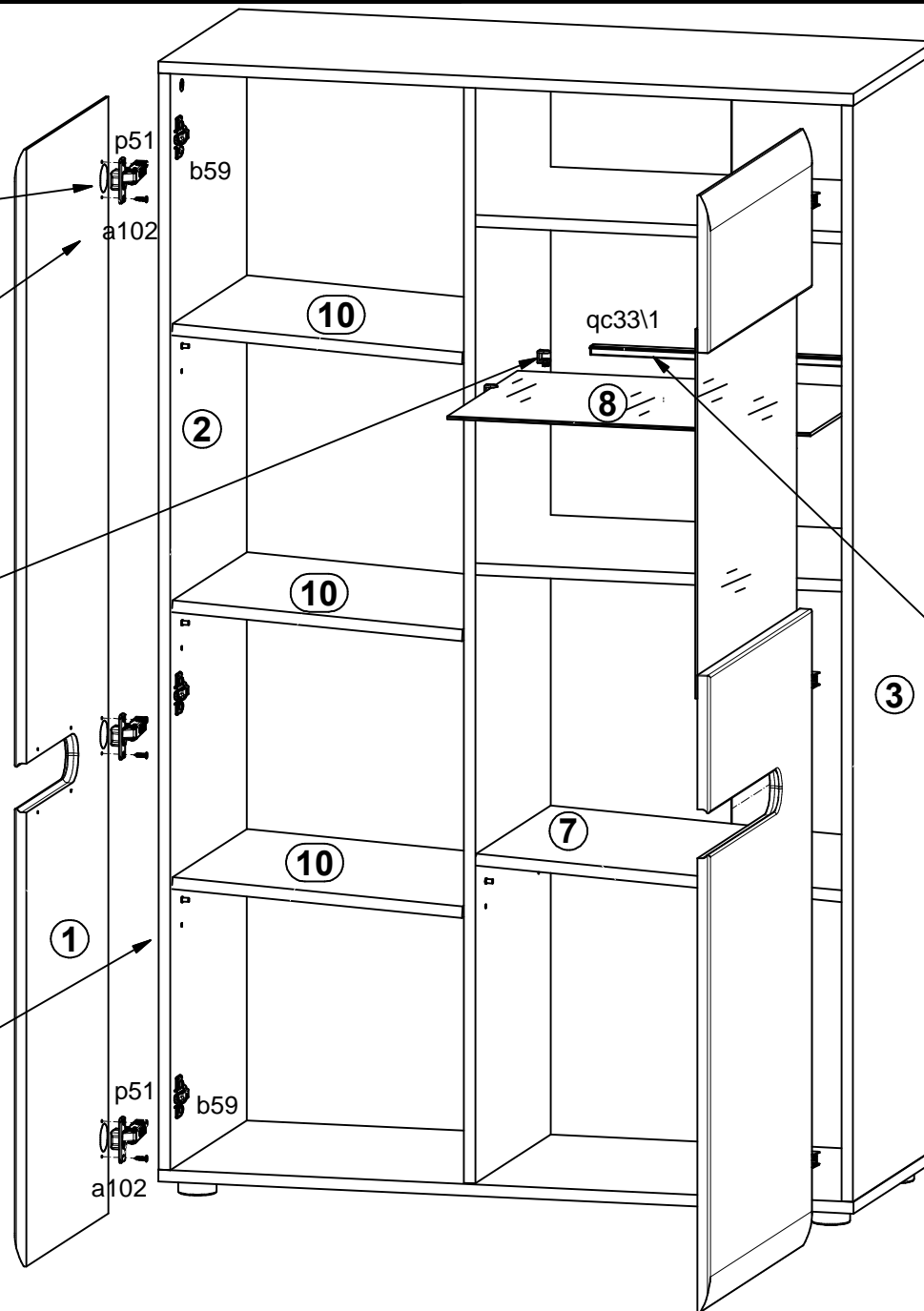
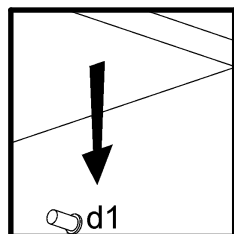
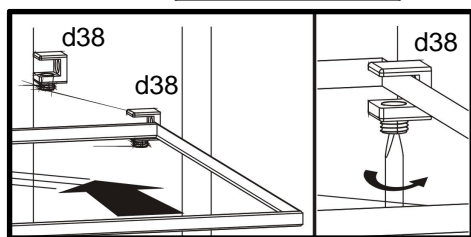
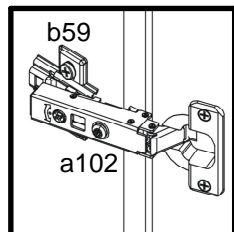
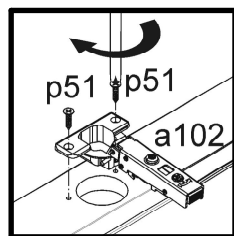

8

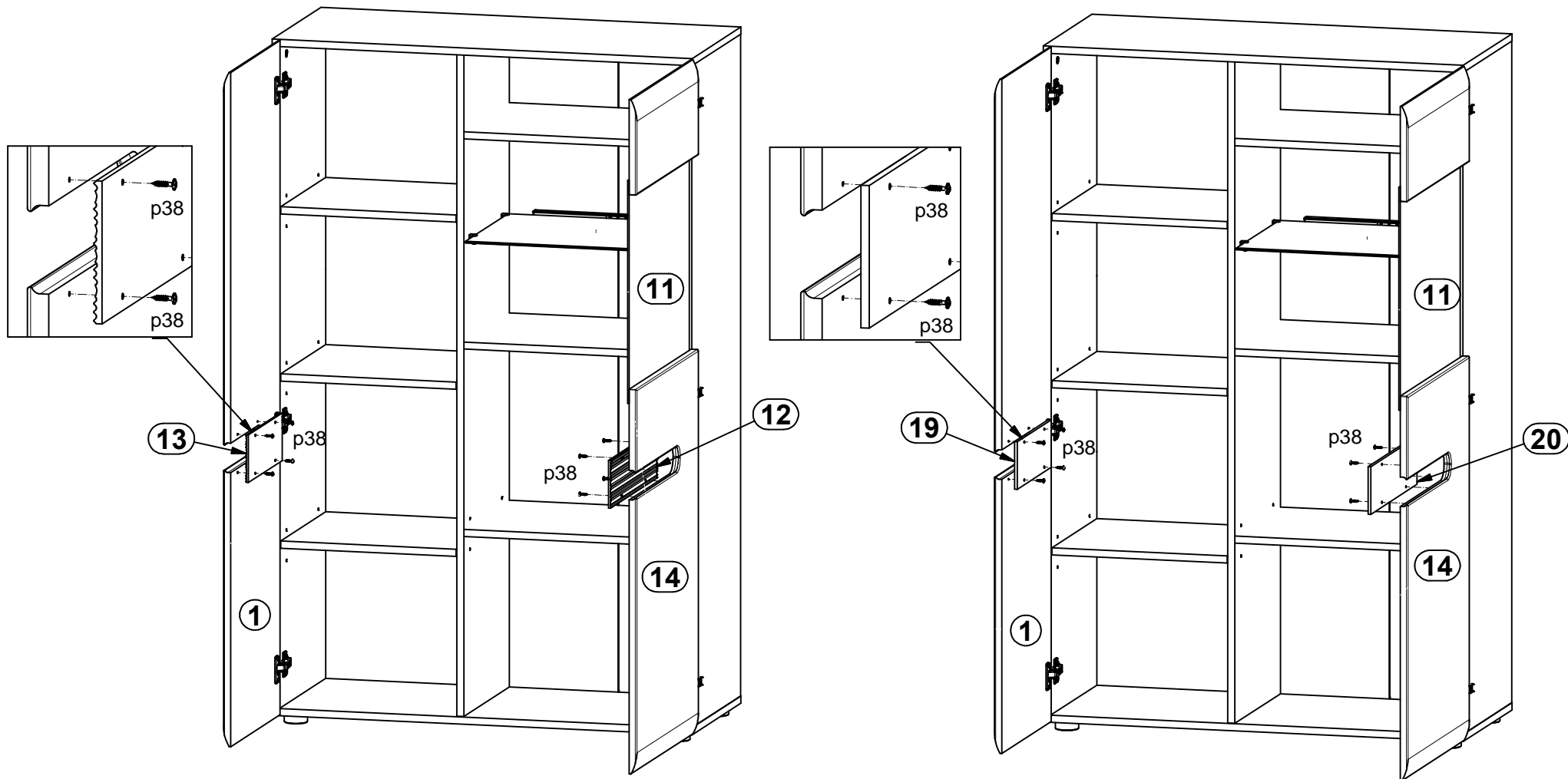

9

