

- D** Montageanleitung
- NL** Handleiding voor de montage
- TR** Montaj talimatı
- FR** Instructions de montage
- CZ** Montážní návod
- HU** Összeszerelési útmutató
- GB** Assembly instructions
- PL** Instrukcja montażu
- RU** Инструкция по монтажу
- IT** Istruzioni di montaggio
- RO** Instructiuni de asamblare
- SK** Montážny návod

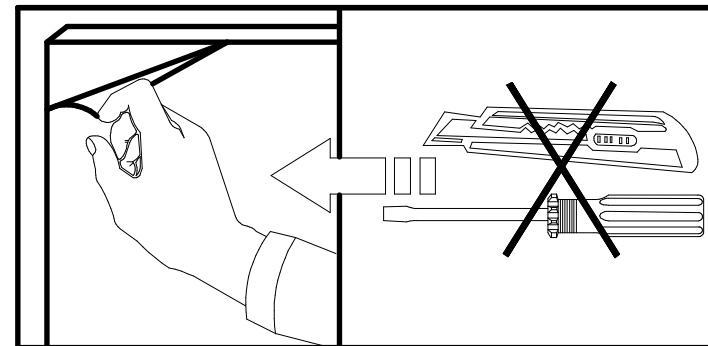

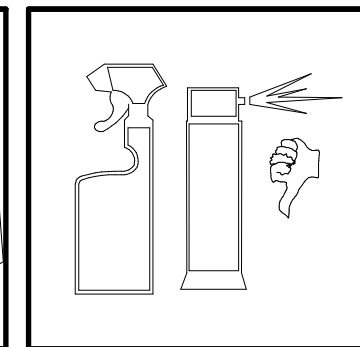

A	B	C (mm)		D
1	S182-001	1246	396	6/7
2	S182-104	1218	360	6/7
3	S182-105	1218	360	6/7
4	S182-106	1218	345	6/7
5	S182-204	800	360	5/7
6	S182-205	800	360	5/7
7	S182-304	375	330	5/7
8	S182-312	375	345	5/7
9	S182-701	396	125	5/7
10	S182-704	396	125	5/7
11	S182-914	1230	389	6/7

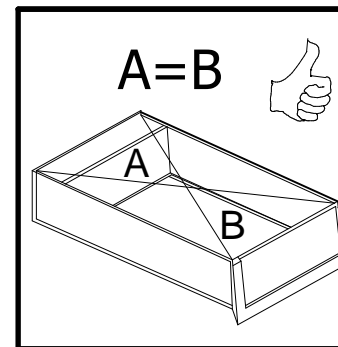
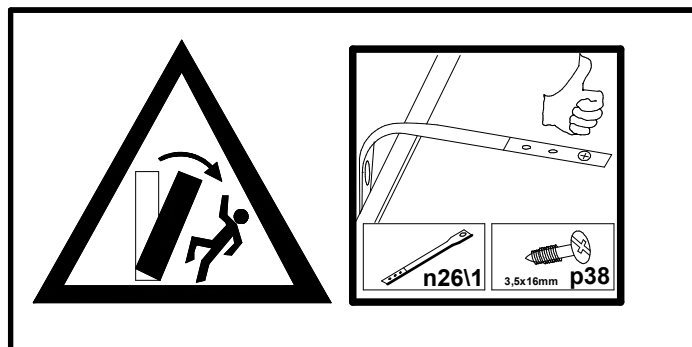
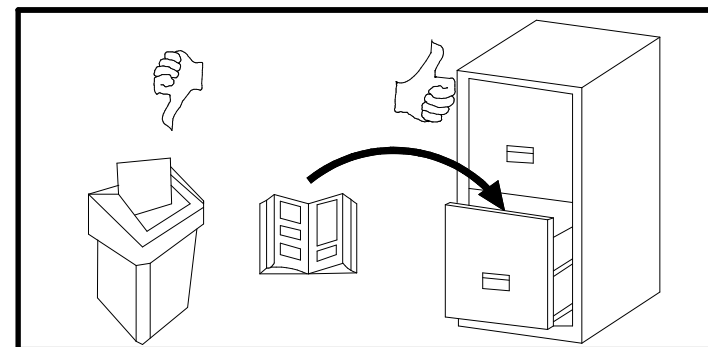
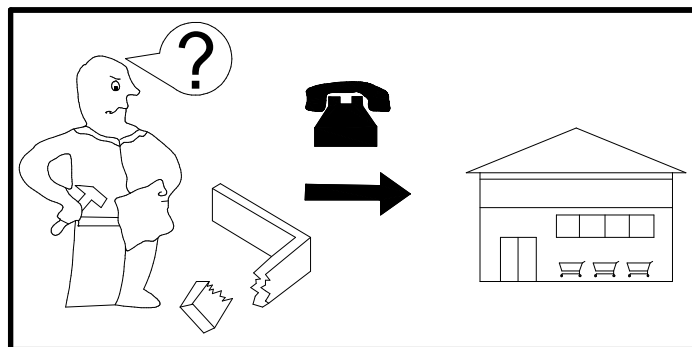
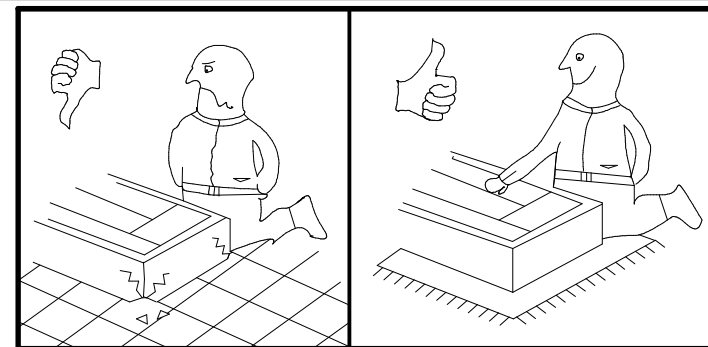
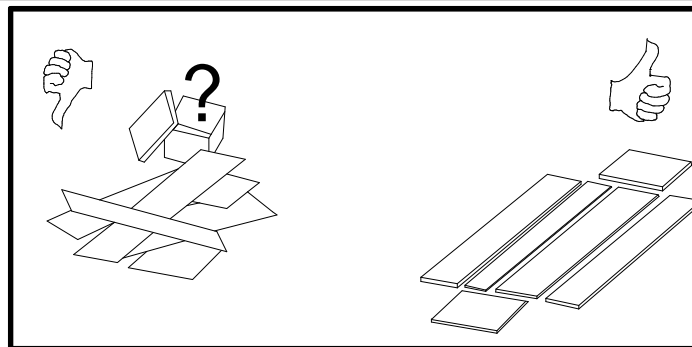
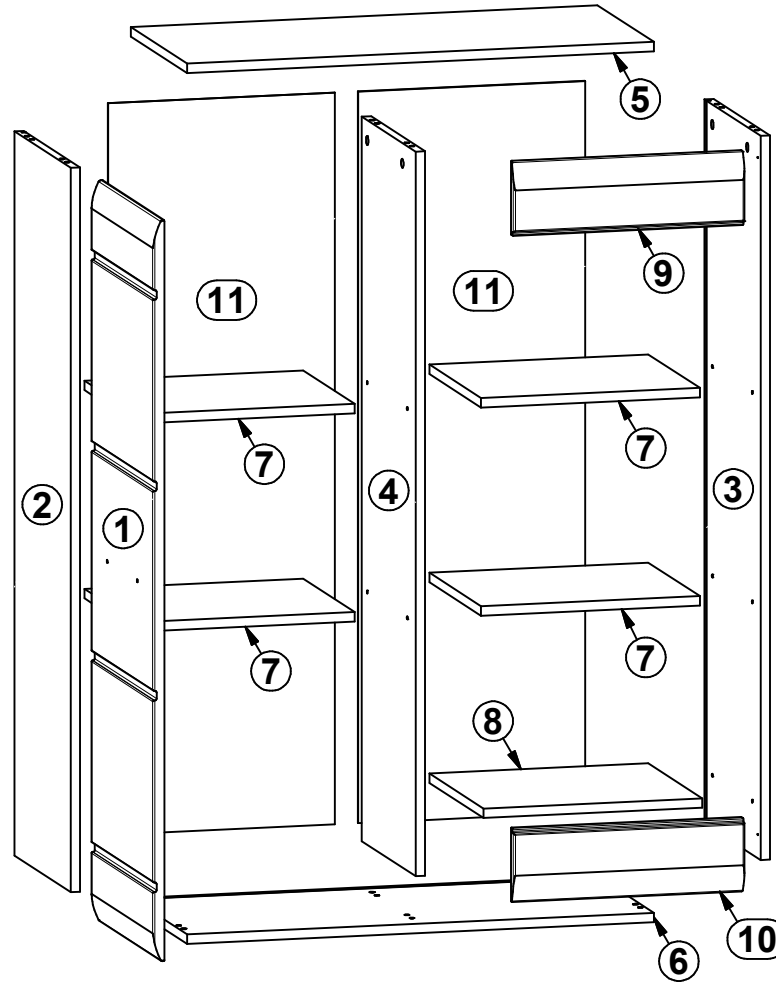
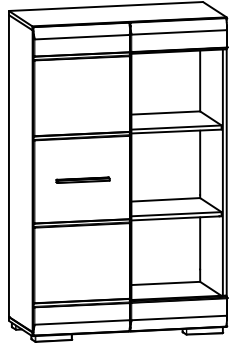
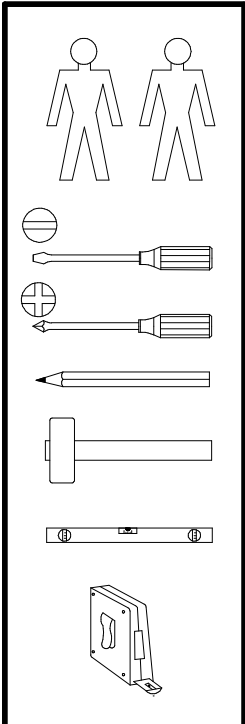

60 min

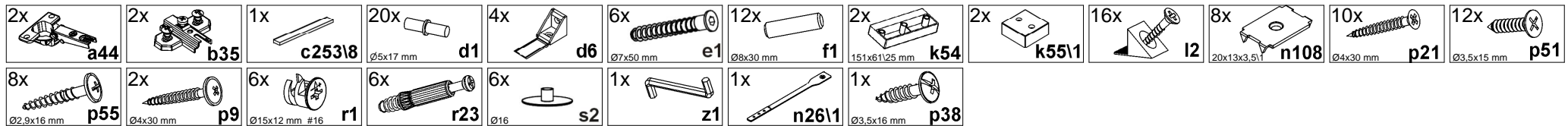
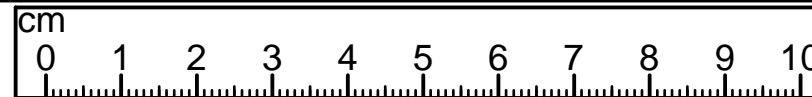
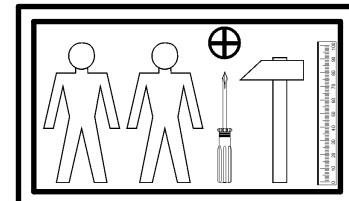

**1**

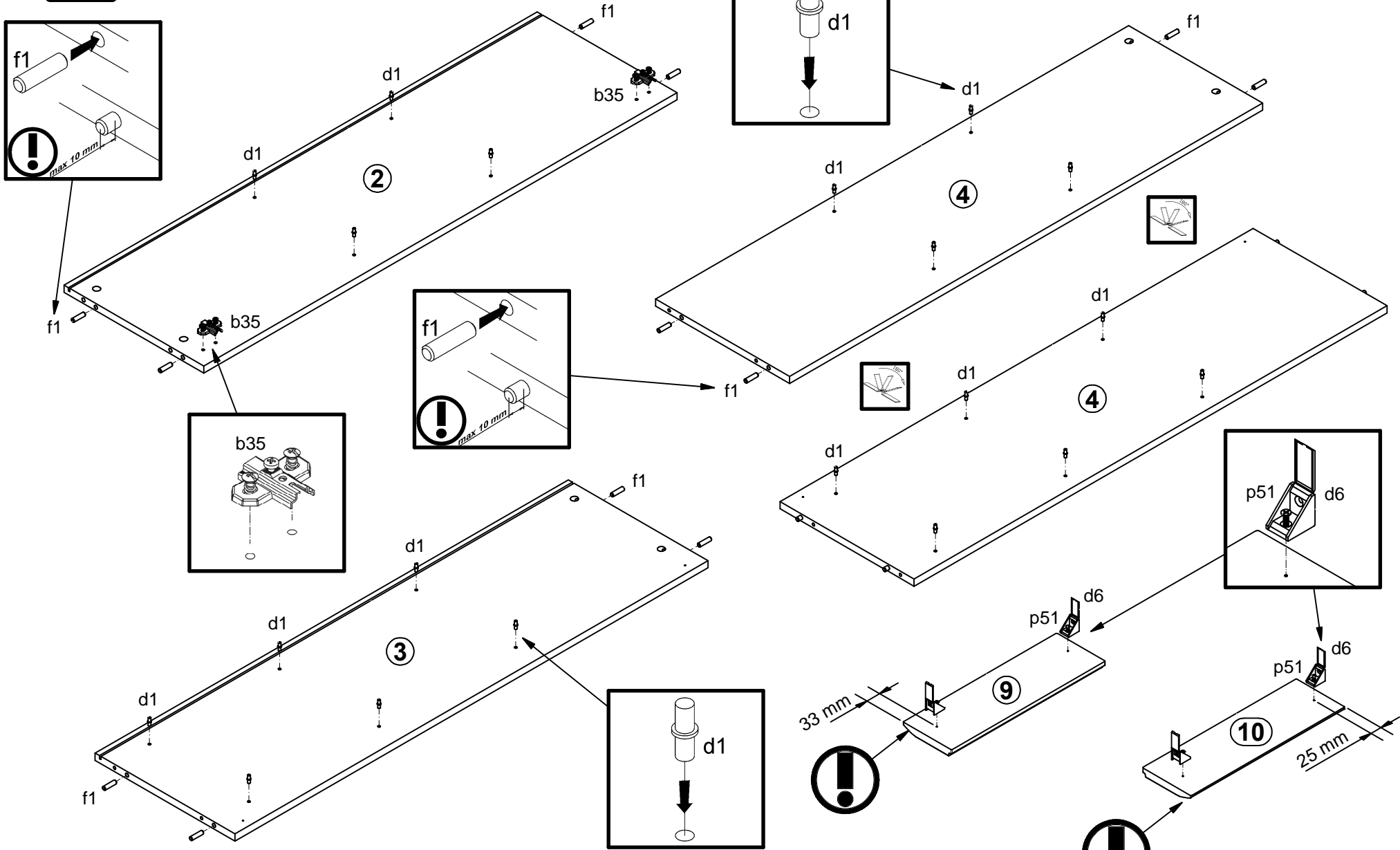
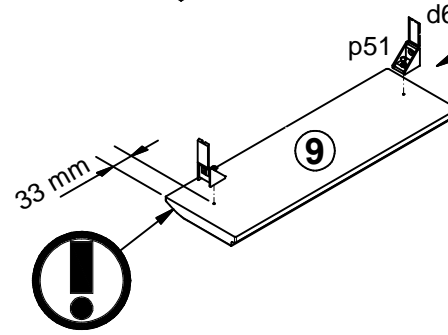
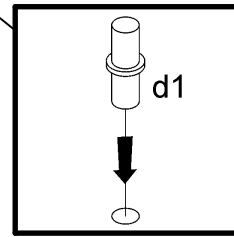
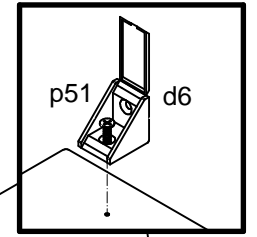
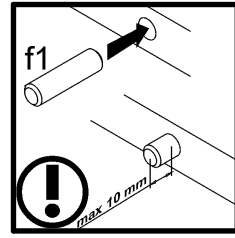
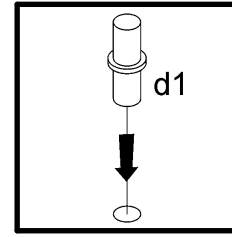
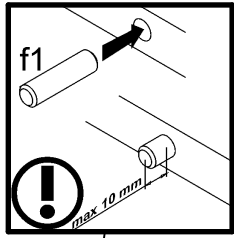

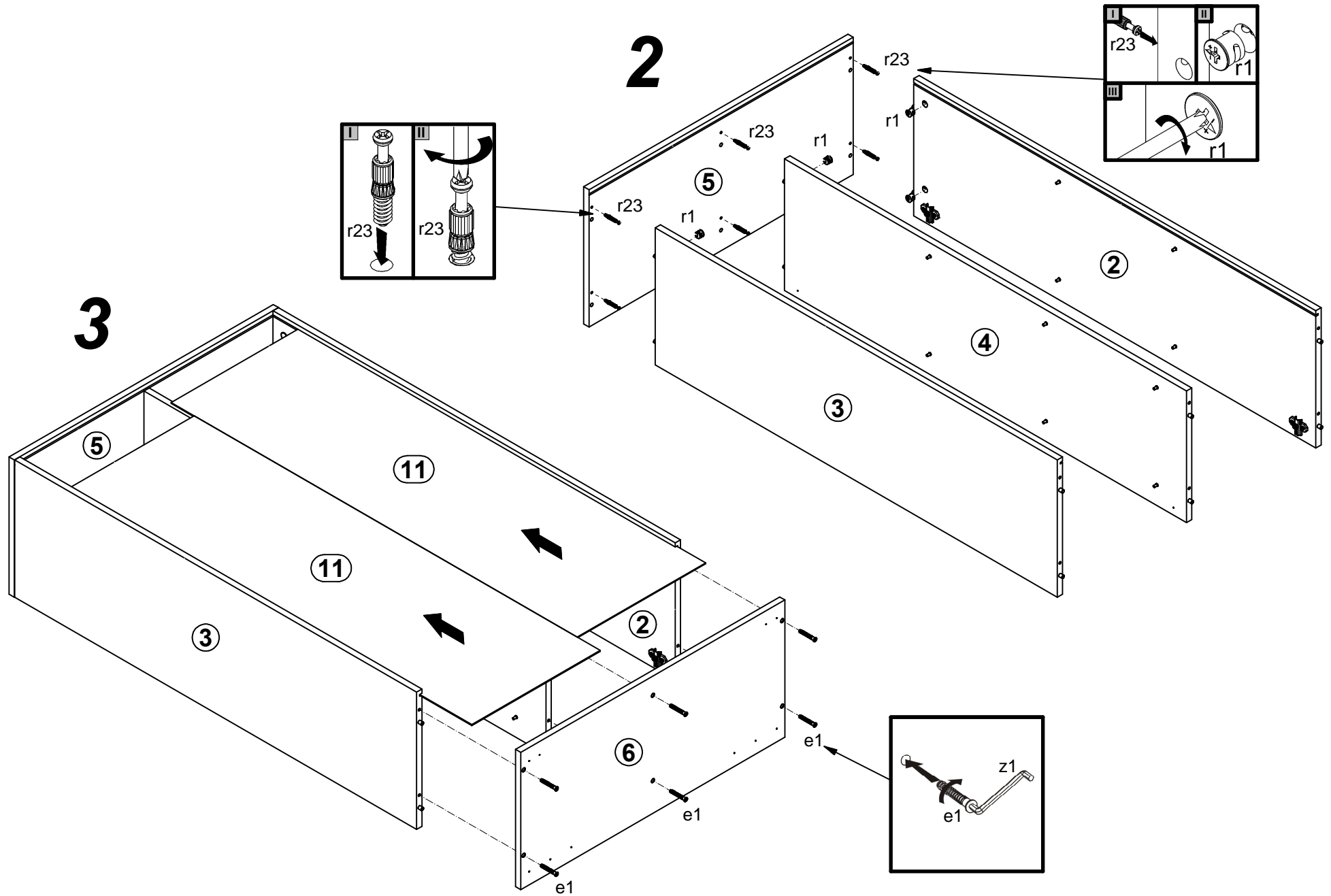



6

10 24 HH 01  
10 24 HG 01

10 24 WW 01

**Pflegehinweis!**

Bitte nur mit einem Staubtuch  
(kein Microfasertuch) oder  
einem feuchten Lappen reinigen.  
KEINE scheuernden Putzmittel  
verwenden!

**Wskazówka dotycząca pielęgnacji!**

Proszę czyścić tylko suchą lub lekko  
wilgotną szmatką do kurzu. Nie używać  
żadnych środków szorstkich!

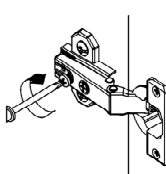
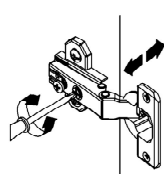
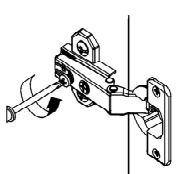
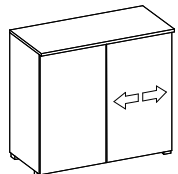
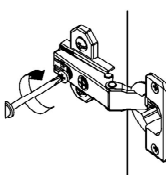
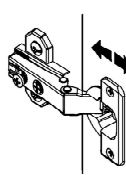
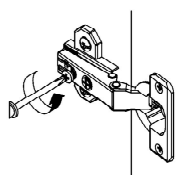
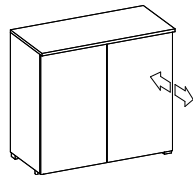
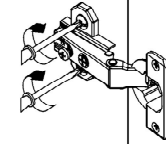
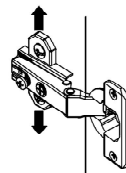
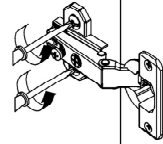
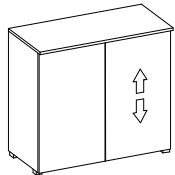
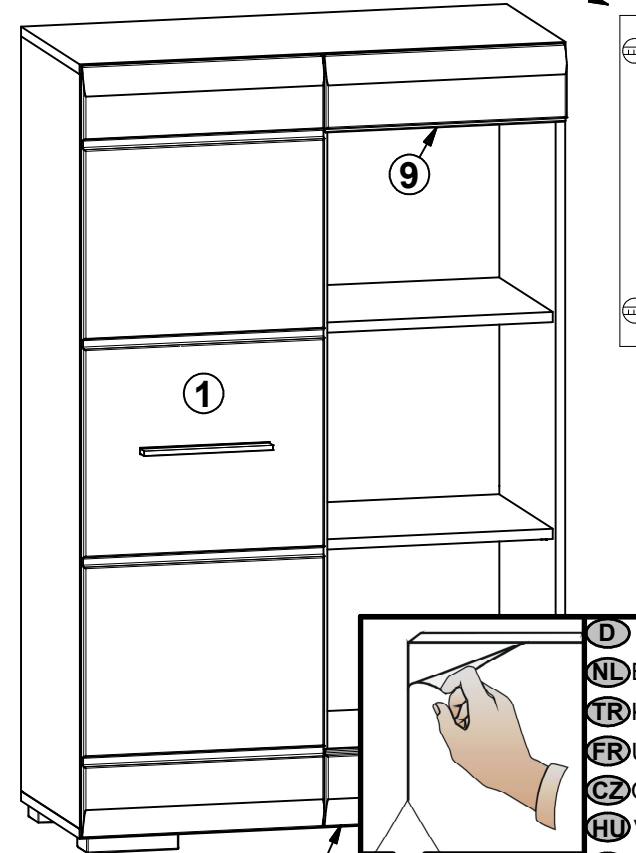
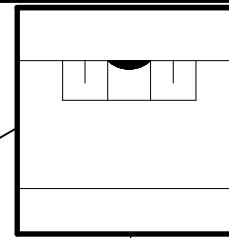

10

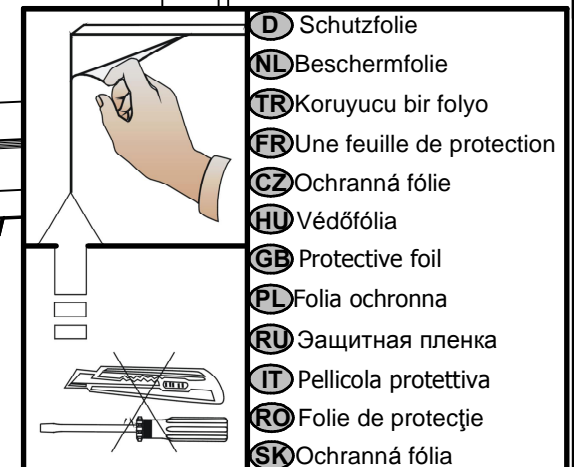

- D** Schutzfolie
- NL** Beschermfolie
- TR** Koruyucu bir folyo
- FR** Une feuille de protection
- CZ** Ochranná fólie
- HU** Védőfólia
- GB** Protective foil
- PL** Folia ochronna
- RU** Э защитная пленка
- IT** Pellicola protettiva
- RO** Folie de protecție
- SK** Ochranná fólia