

A	B	C (mm)			D
1	L30-009	824	450	19	3/4
2	L30-010	450	203	18	4/4
3	L30-107	864	400	36	1/4
4	L30-108	864	400	36	1/4
5	L30-109	828	371	16	1/4
6	L30-110	828	371	16	1/4
7	L30-202	1498	420	36	2/4
8	L30-306	1366	371	36	2/4
9	L30-307	447	350	16	2/4
10	L30-405	1366	40	16	2/4
11	L30-905	838	446	2,5	3/4
12	L30-906	838	457	2,5	3/4
13	L30-907	838	457	2,5	3/4
14	L30-908	411	355	2,5	1/4
15	ZS3-5594	389	160	15	1/4
16	ZS4-537	350	160	12	1/4
17	ZS4-538	350	160	12	1/4

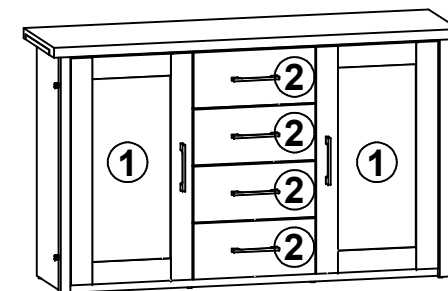





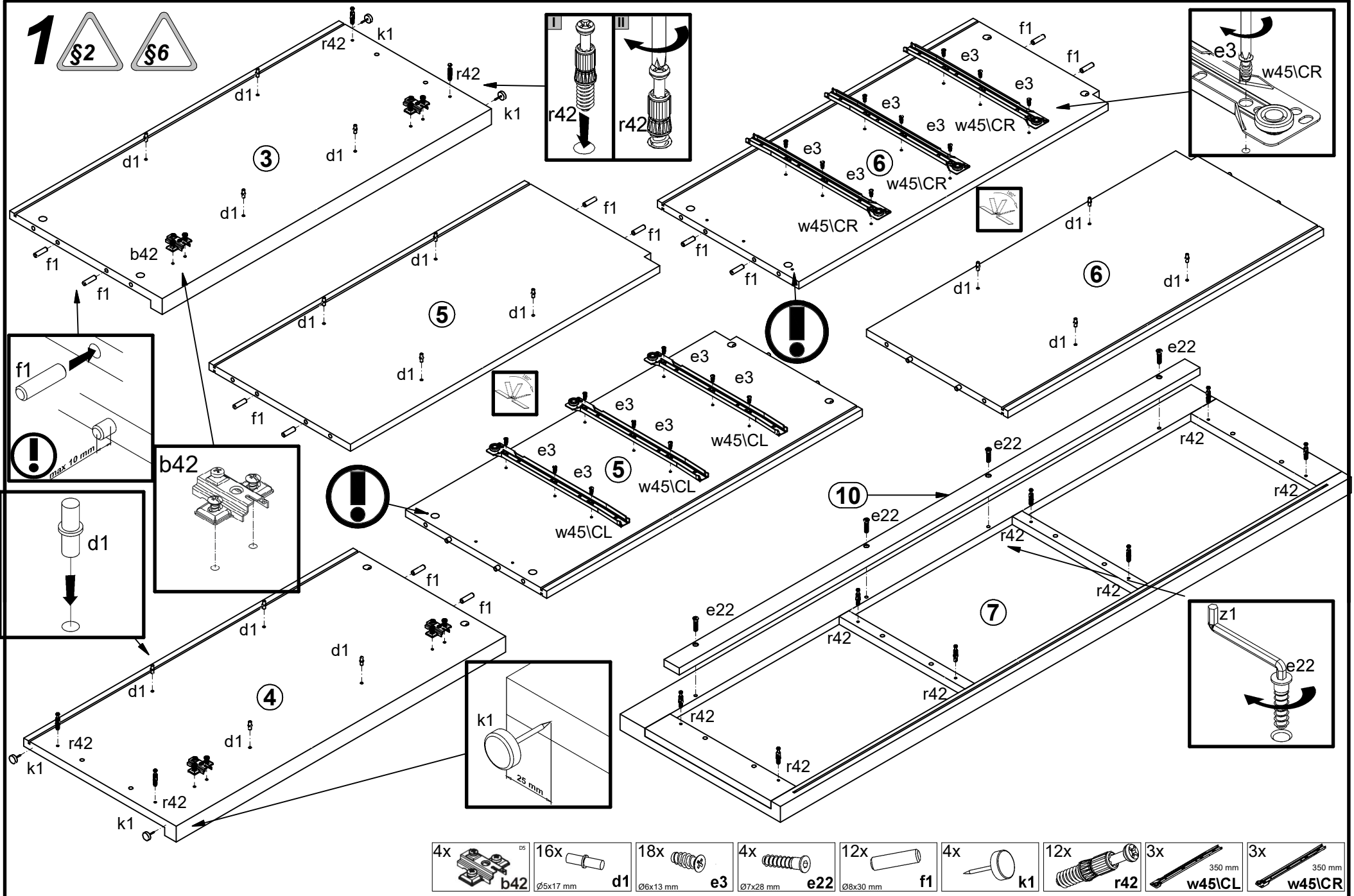

D
1/4

4x K18 Ø35 a172	4x b42	6x 128 mm c452	16x Ø5x17 mm d1	24x Ø6x13 mm e3	16x Ø5x9 mm e19	4x Ø7x28 mm e22	16x Ø8x30 mm f1	8x Ø6x30 mm f9	16x Ø6,5x40 mm f25	12x M4x25 mm j8	6x k1	2x M6/Ø14x14 mm k39\I2
2x M6/22 mm k39\I3	12x l2	12x Ø3,5x16 mm p38	8x Ø3,5x15 mm p51	16x Ø15x12 mm #16 r1	16x Ø12x10,5 mm #12 r15	32x r42	8x Ø16 s2	4x 350 mm w45\CL	4x 350 mm w45\CR	4x 350 mm w45\DL	4x 350 mm w45\DR	1x z1
1x n26\I1	1x Ø3,5x16 mm p38											

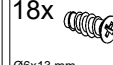
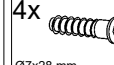
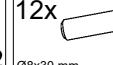
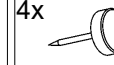

1 §2 §6

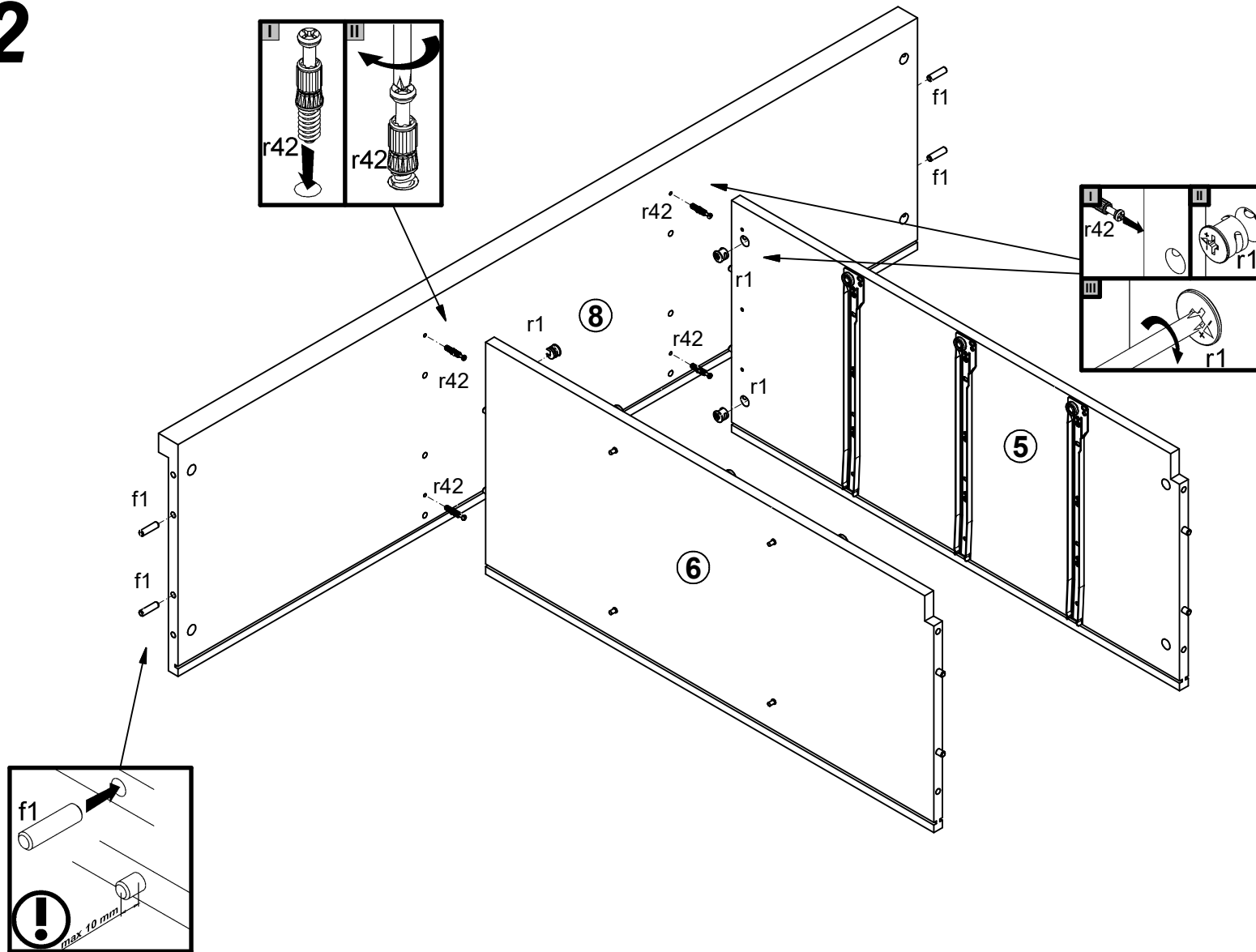

- 4x  **b42**
- 16x  **d1**
- 18x  **e3**
- 4x  **e22**
- 12x  **f1**
- 4x  **k1**
- 12x  **r42**
- 3x  **w45\CL**
- 3x  **w45\CR**

2



- 4x  f1 Ø8x30 mm
- 4x  r1 Ø15x12 mm #16
- 4x  r42

3

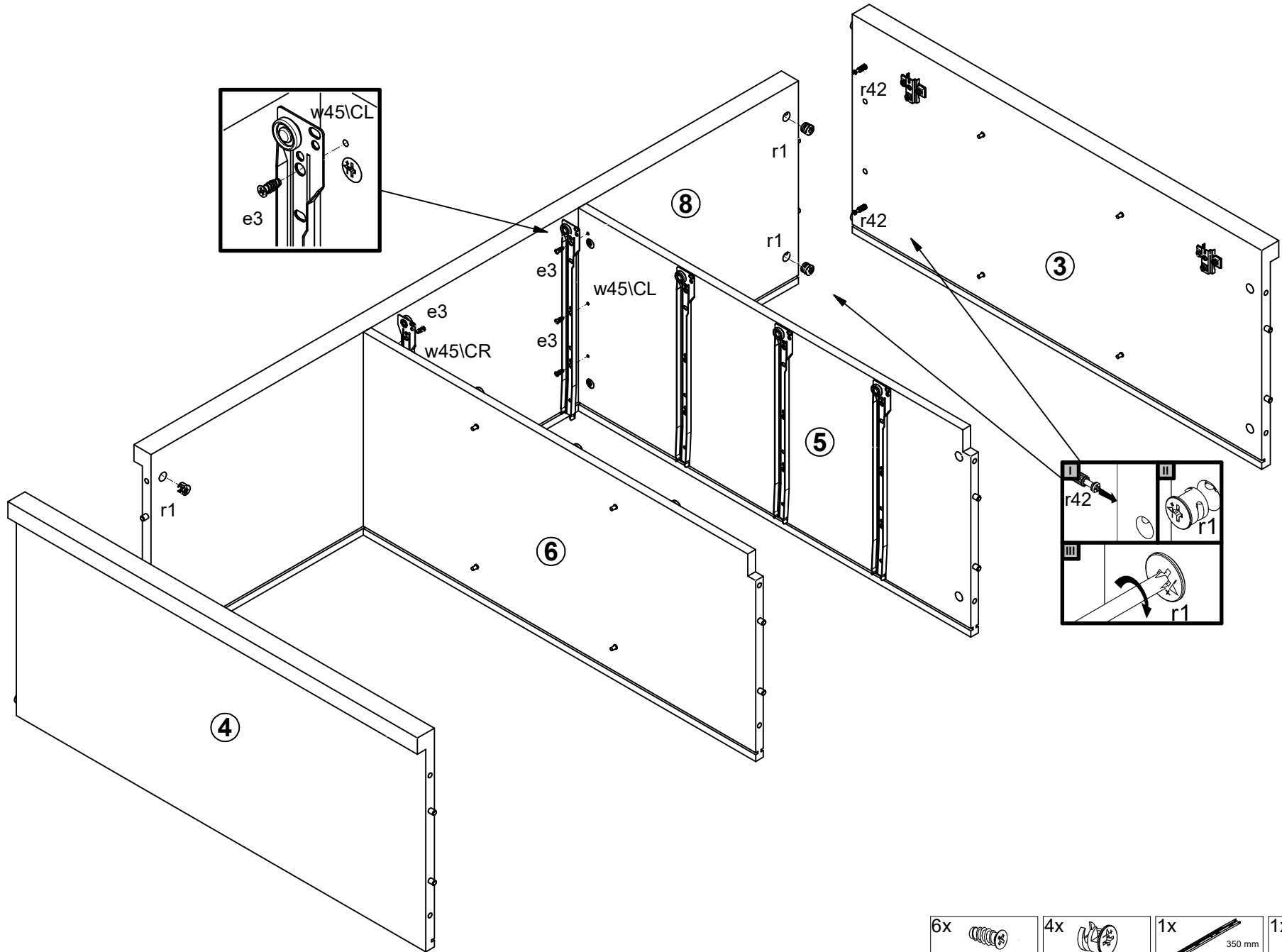

- | | | | |
|----------------------|---------------------------|------------------------|------------------------|
| 6x
Ø6x13 mm
e3 | 4x
Ø15x12 mm #16
r1 | 1x
350 mm
w45\CL | 1x
350 mm
w45\CR |
|----------------------|---------------------------|------------------------|------------------------|

4

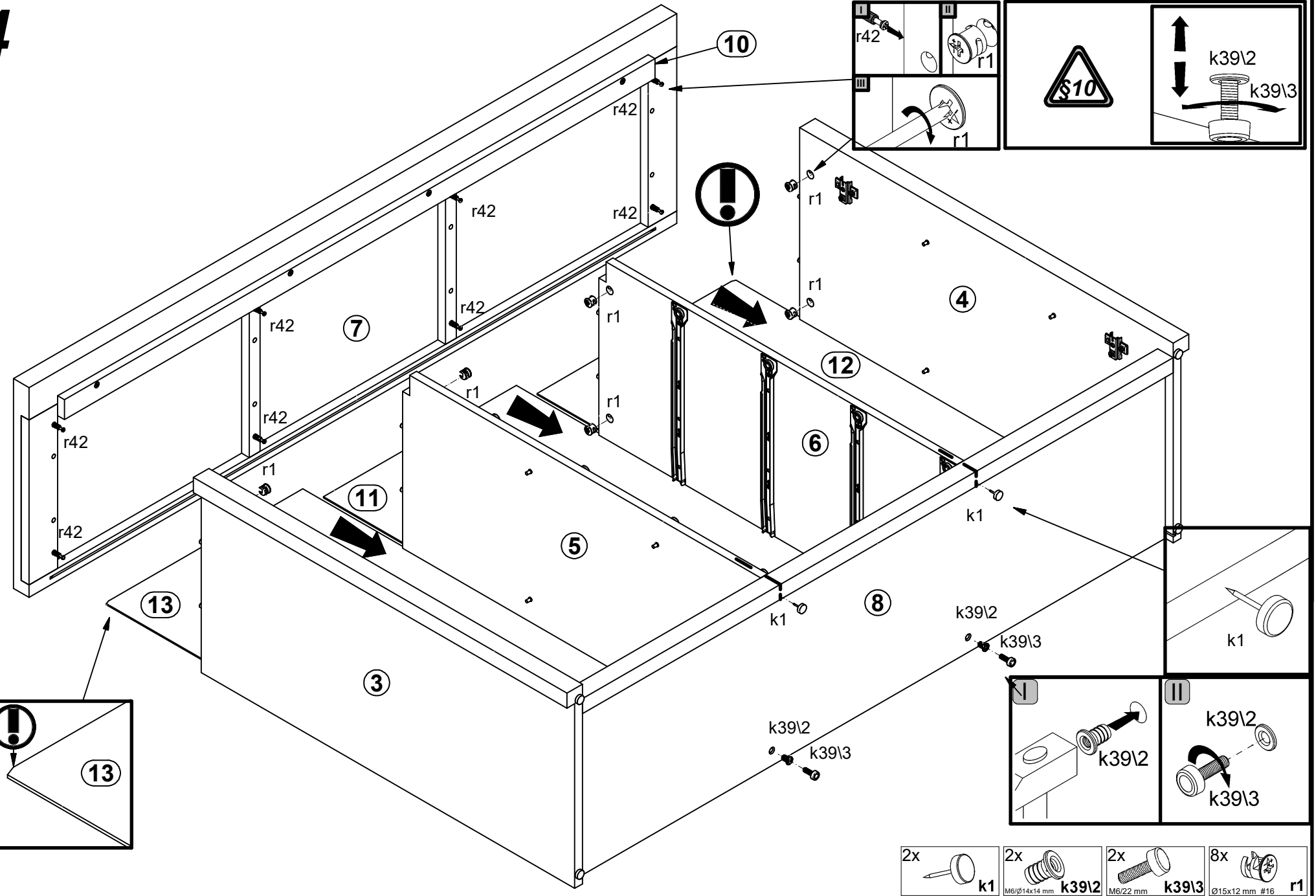

- 2x k1
- 2x M6/Ø14x14 mm k39/2
- 2x M6/22 mm k39/3
- 8x Ø15x12 mm #16 r1

5

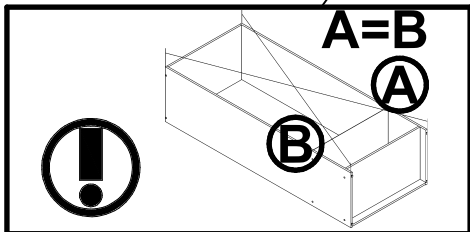
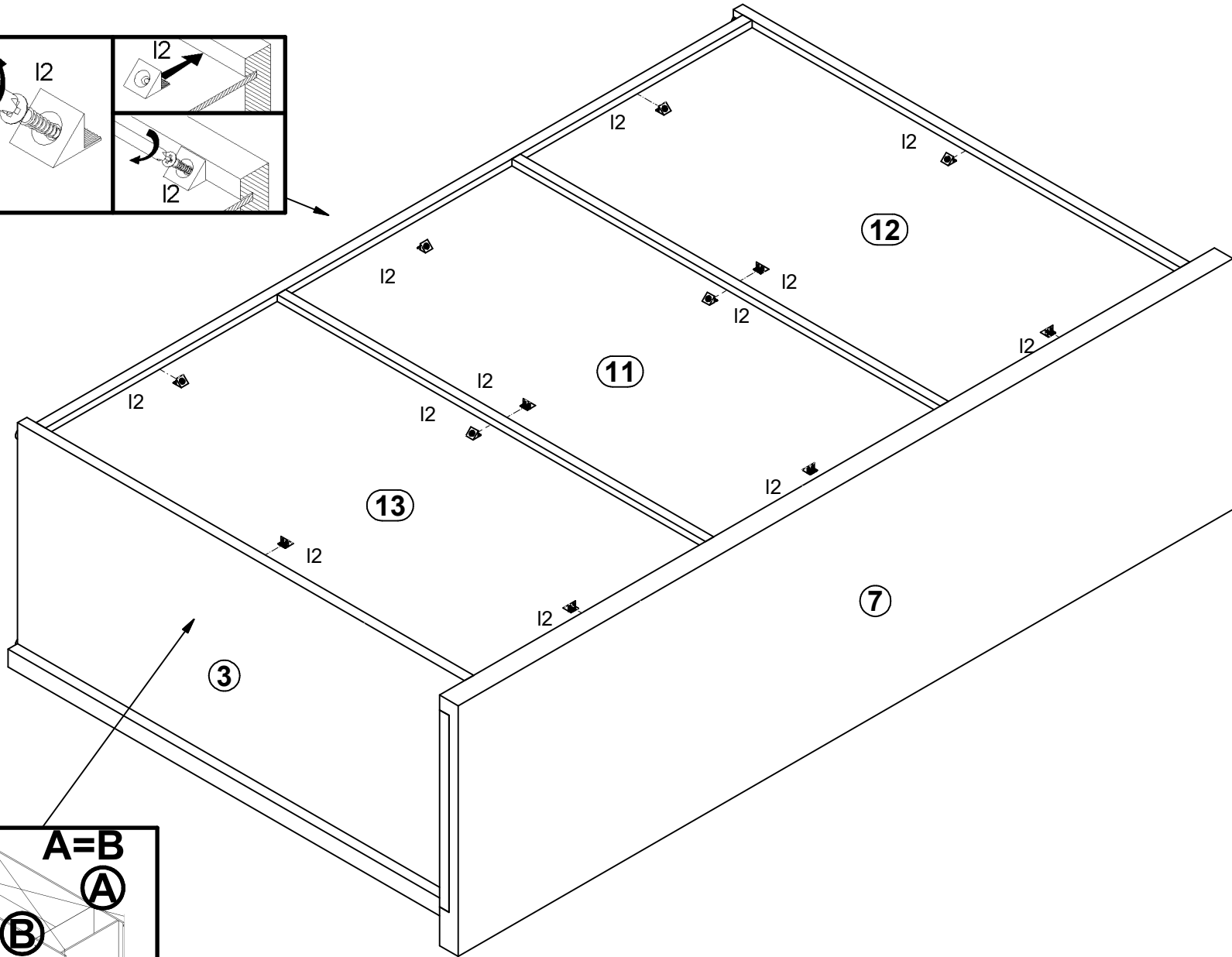
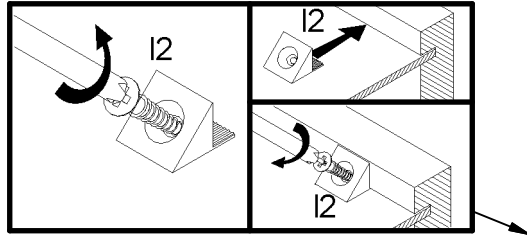

7

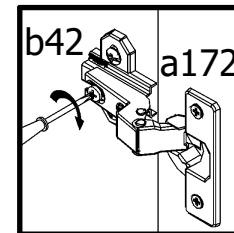
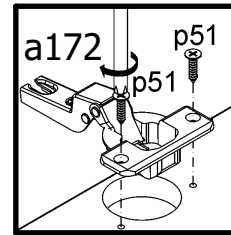
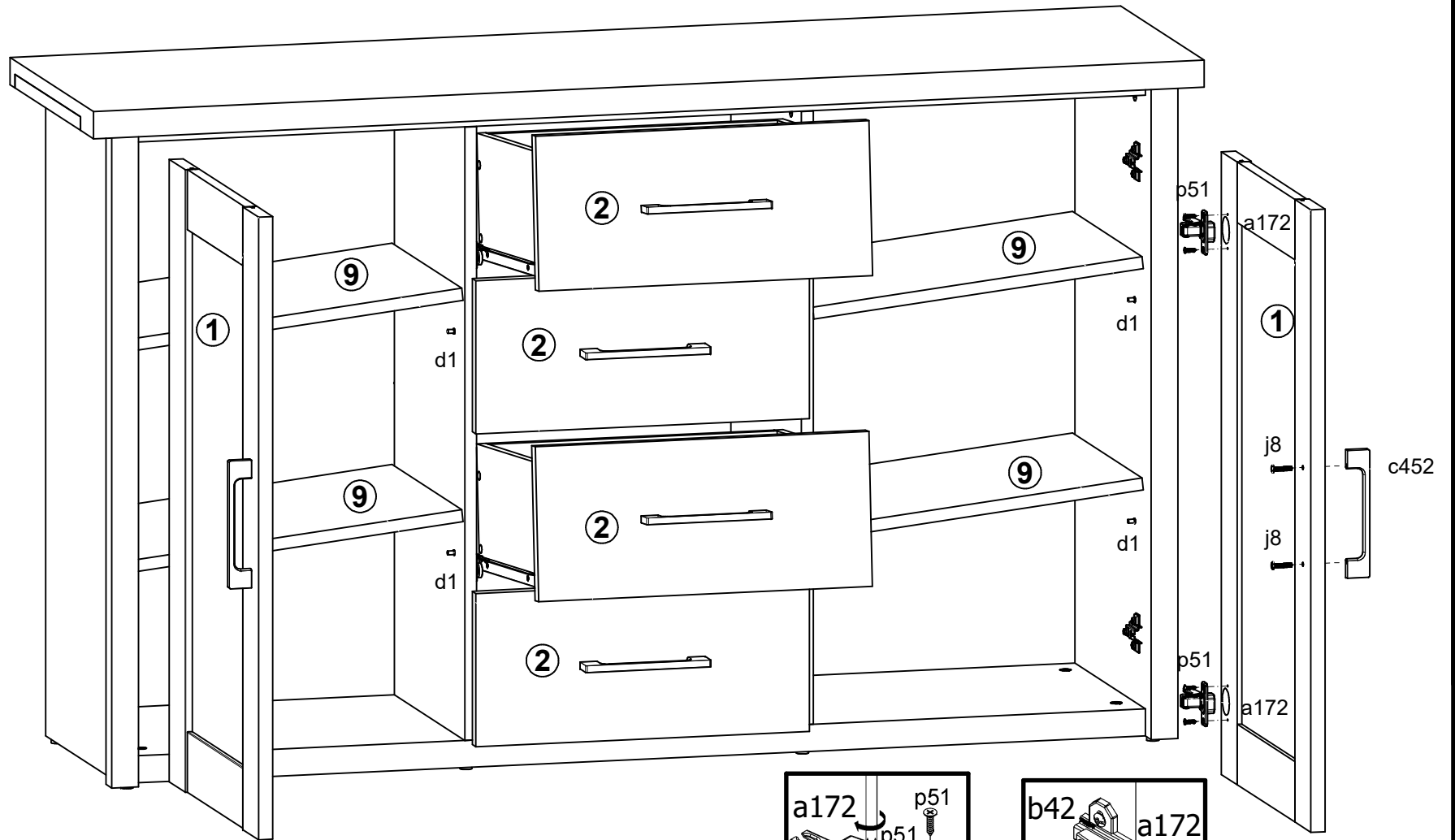
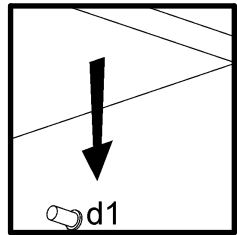

- | | | | |
|------------------------------|-----------------------------|-----------------------------|--------------------------------|
| 4x
K18 Ø35
a172 | 2x
128 mm
c452 | 4x
M4x25 mm
j8 | 8x
Ø3,5x15 mm
p51 |
|------------------------------|-----------------------------|-----------------------------|--------------------------------|

8

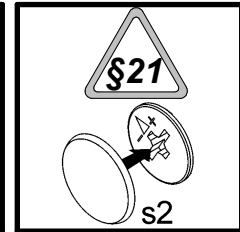
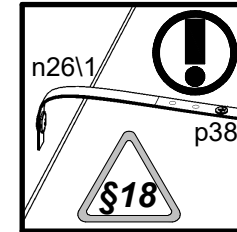
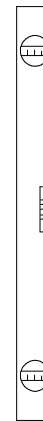
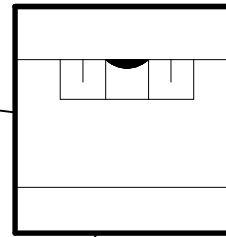
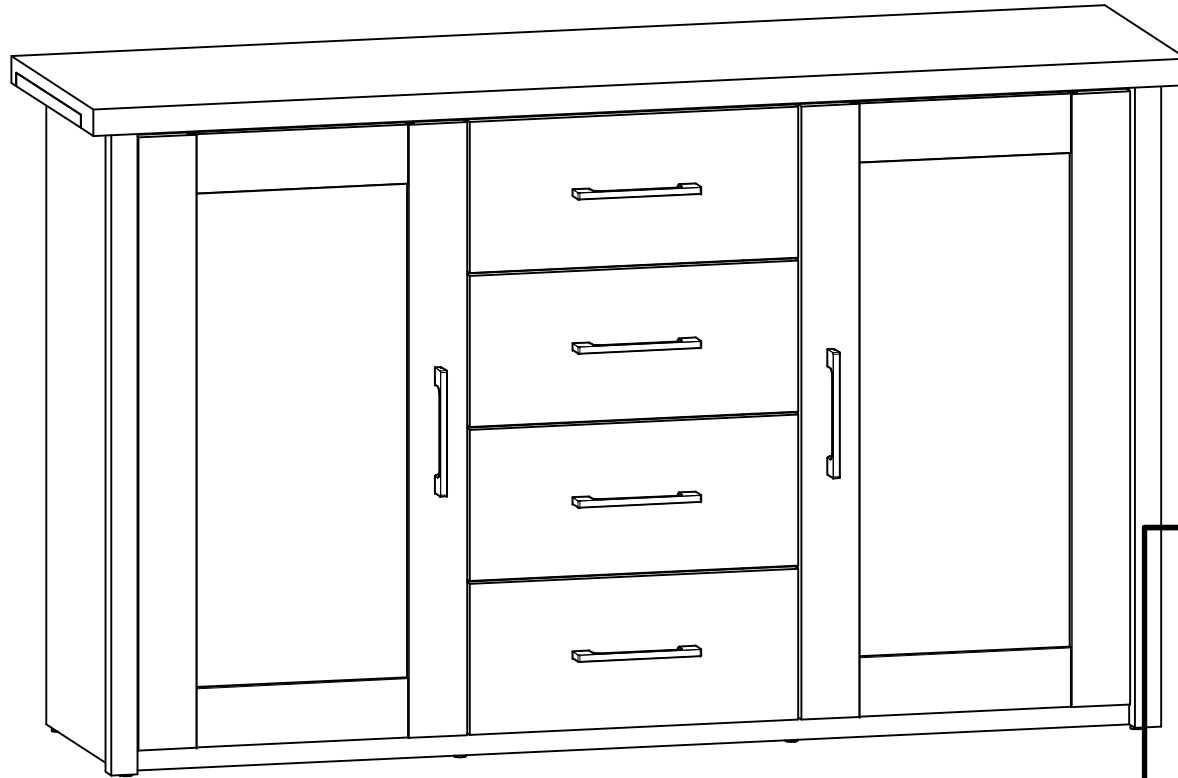



n26\1

p38

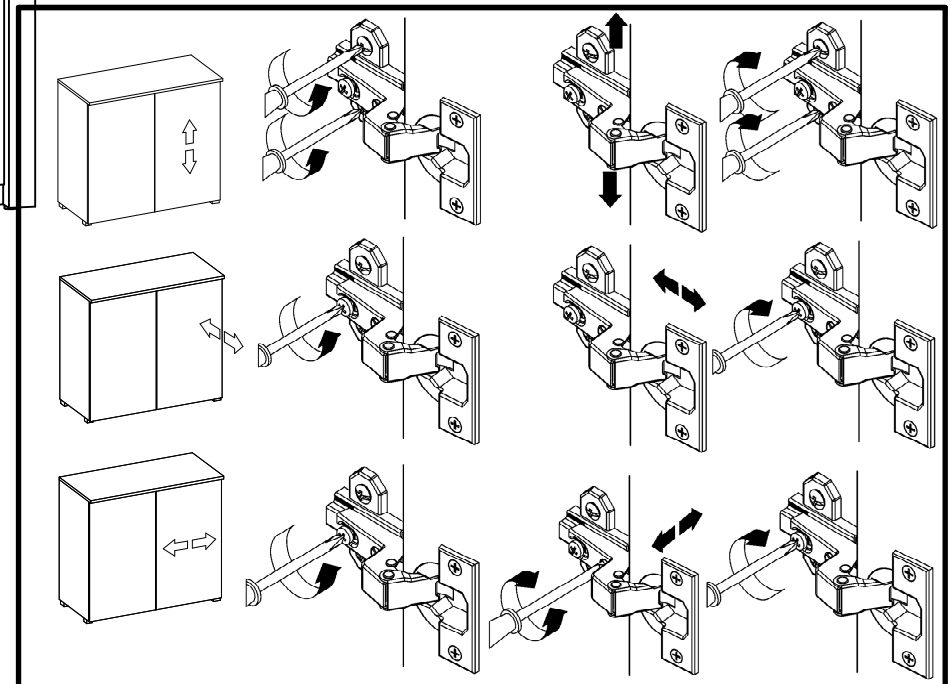
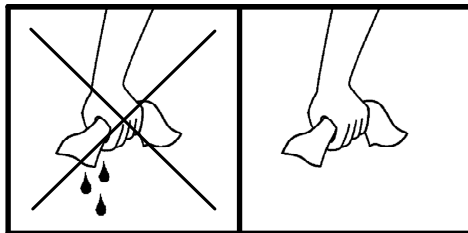
s2

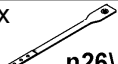

- 1x  n26\1
- 1x  p38
Ø3.5x16 mm
- 8x  s2
Ø16