

A	B	C (mm)			D
1	L30-001	2040	450	19	5/5
2	L30-002	2040	450	19	5/5
3	L30-003	2040	450	19	5/5
4	L30-004	2040	450	19	5/5
5	L30-005	2040	450	19	5/5
6	L30-101	2080	585	36	1/5
7	L30-102	2080	585	36	1/5
8	L30-103	2044	556	16	2/5
9	L30-104	2044	556	16	2/5
10	L30-201	2406	615	36	3/5
11	L30-301	2274	556	36	3/5
12	L30-302	902	535	22	4/5
13	L30-304	438	535	16	4/5
14	L30-305	437	535	16	4/5
15	L30-401	2274	40	16	3/5
16	L30-901-01	2054	910	2,5	1/5
17	L30-902	2054	446	2,5	1/5
18	L30-903-01	2054	910	2,5	1/5
19	dr-897	897	30	15	4/5

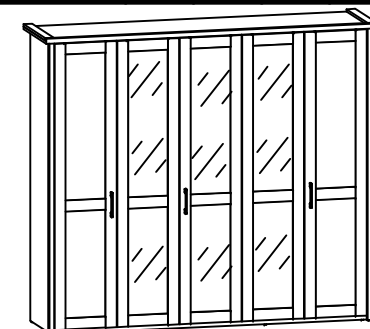

D
4/5

4x K18 Ø35 <b>a172</b>	6x K9 Ø35 <b>a173</b>	4x hamulec <b>a203</b>	6x Ø35 <b>a205</b>	10x Ø5 <b>b42</b>	10x Ø2 <b>b90</b>	3x 128 mm <b>c452</b>	12x Ø5x17 mm <b>d1</b>	5x <b>d20</b>	5x Ø6,3x13 mm <b>e2</b>	4x Ø7x28 mm <b>e22</b>	16x Ø8x30 mm <b>f1</b>	6x M4x25 mm <b>i8</b>
8x <b>k1</b>	2x M6/214x14 mm <b>k3912</b>	2x M6/22 mm <b>k3913</b>	58x <b>l2</b>	4x <b>n158</b>	4x Ø3,5x13 mm <b>p1</b>	40x Ø3,5x15 mm <b>p51</b>	24x Ø15x12 mm #16 <b>r1</b>	18x Ø20x12 mm #16 <b>r36</b>	18x <b>r37</b>	24x <b>r42</b>	4x <b>s1</b>	24x Ø16 <b>s2</b>
1x <b>z1</b>	2x 88x21x15x1,5 <b>n1412</b>	4x Ø3,5x16 mm <b>p38</b>	2x Ø10x50 mm <b>f35</b>	2x Ø5x60 mm <b>p17</b>								

1 §2

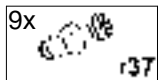
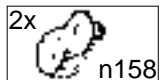
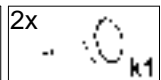
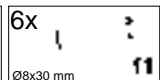
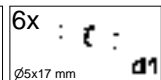
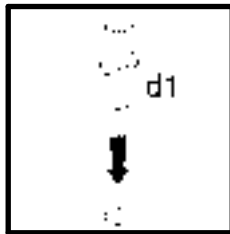
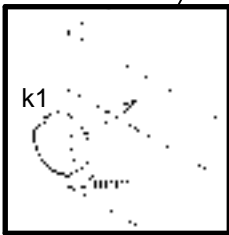
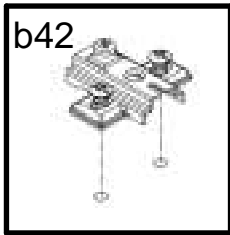
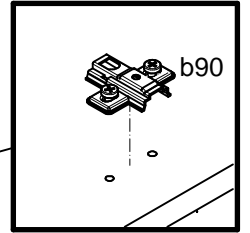
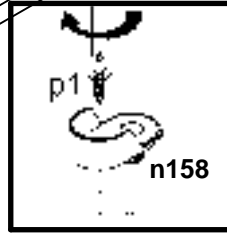
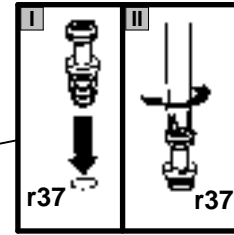
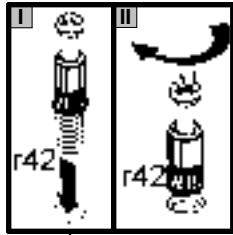

# 2

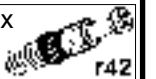
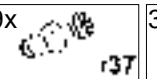
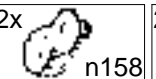
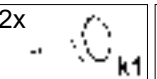
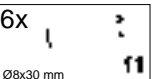
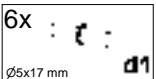
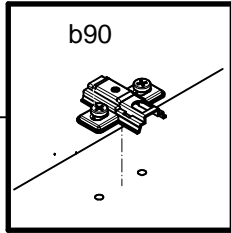
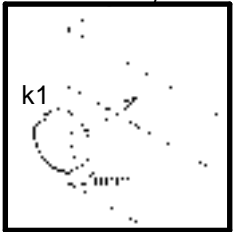
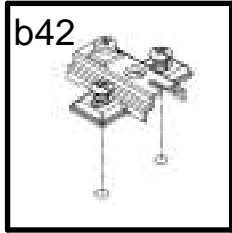
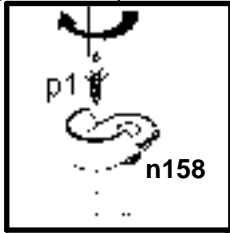
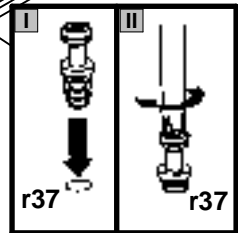
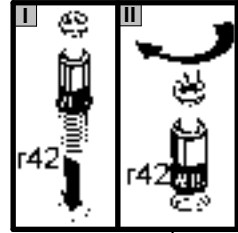
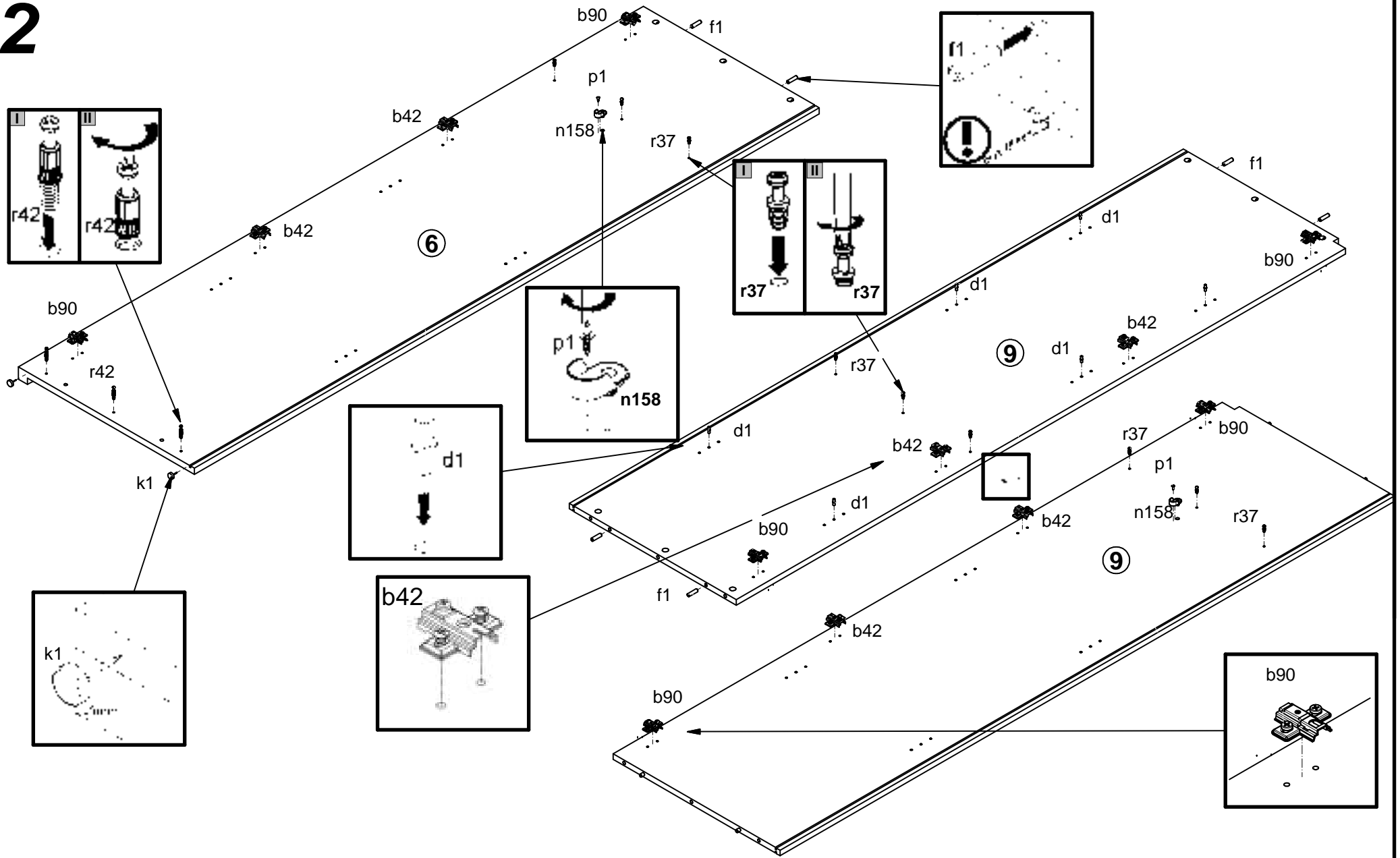

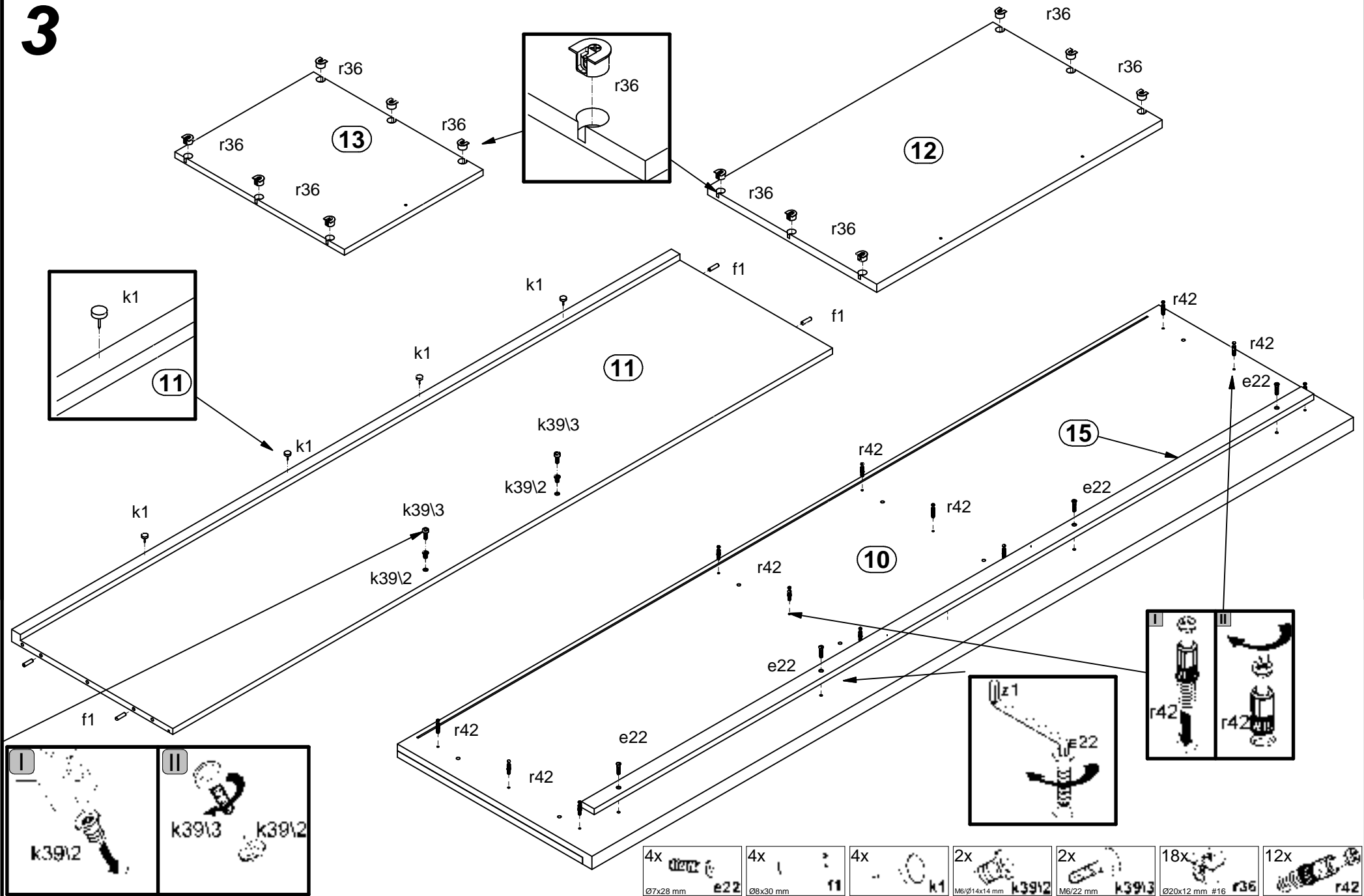

3



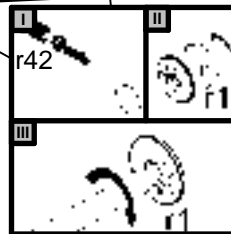
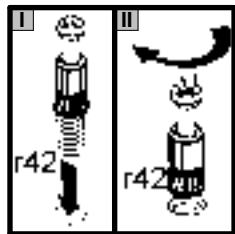
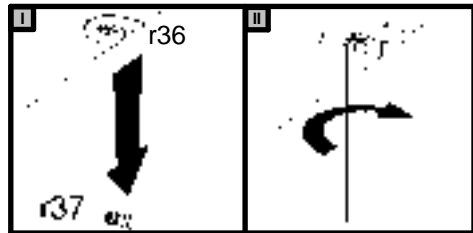
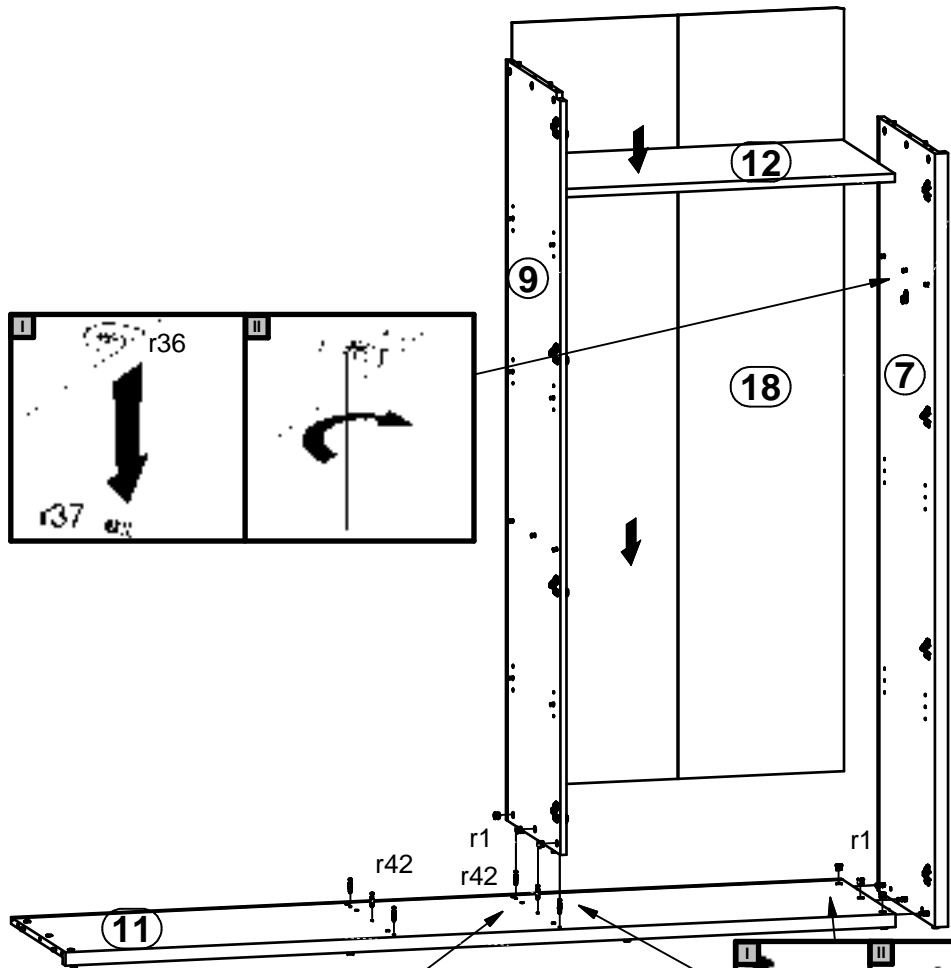

4  

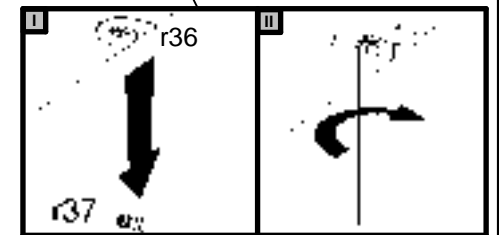
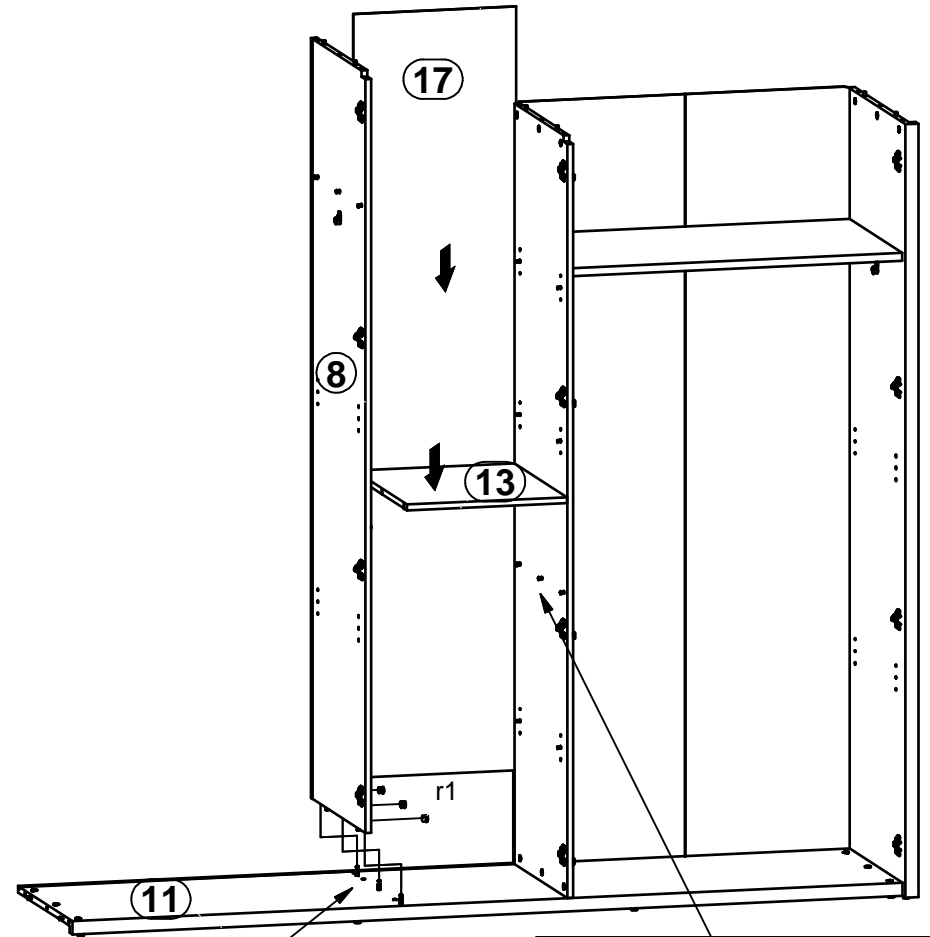

6x  r1  r42

5 



3x  r1

6

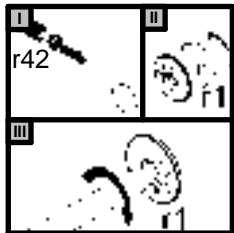
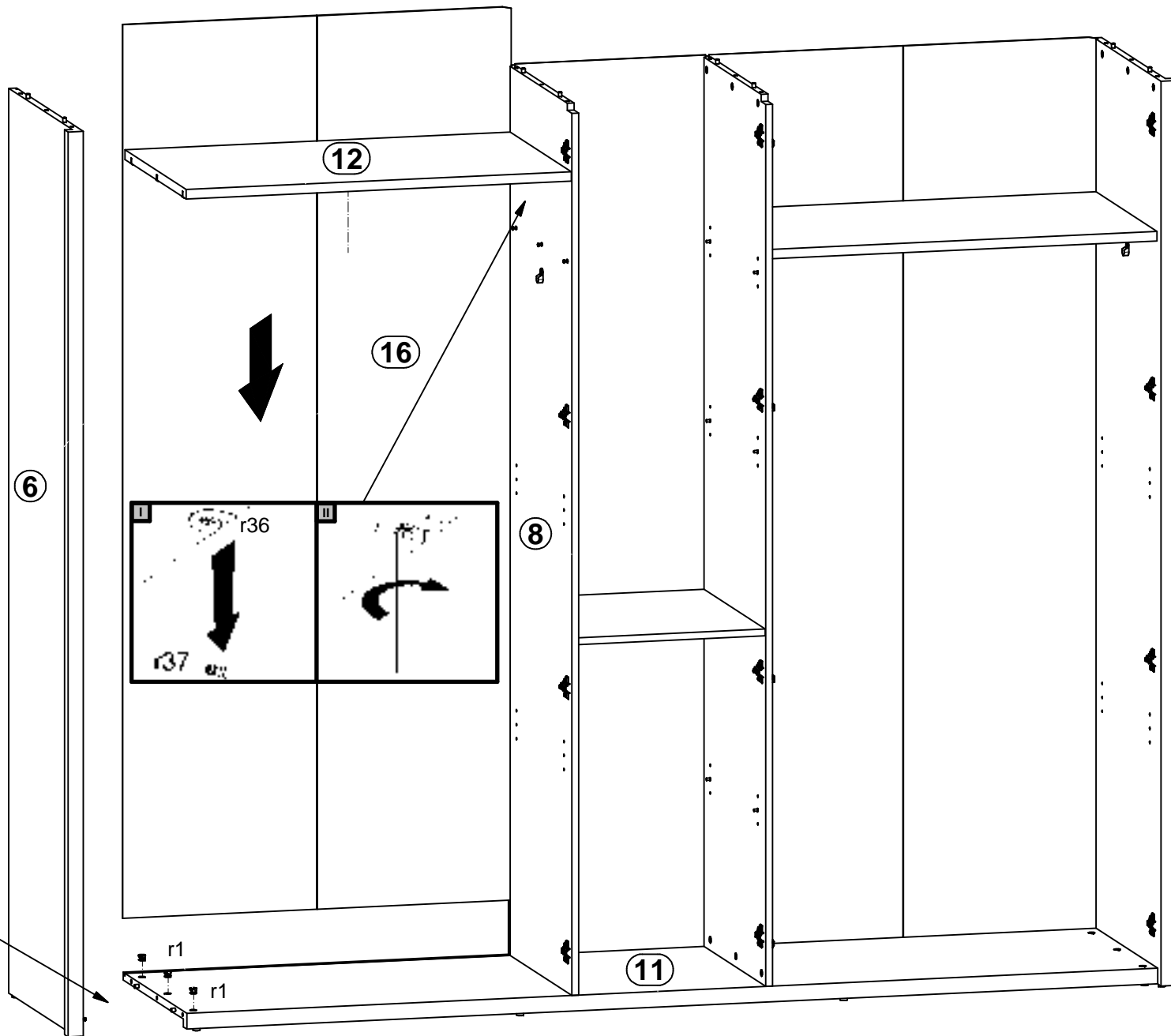

3x  r1  
Ø15x12 mm #16

7

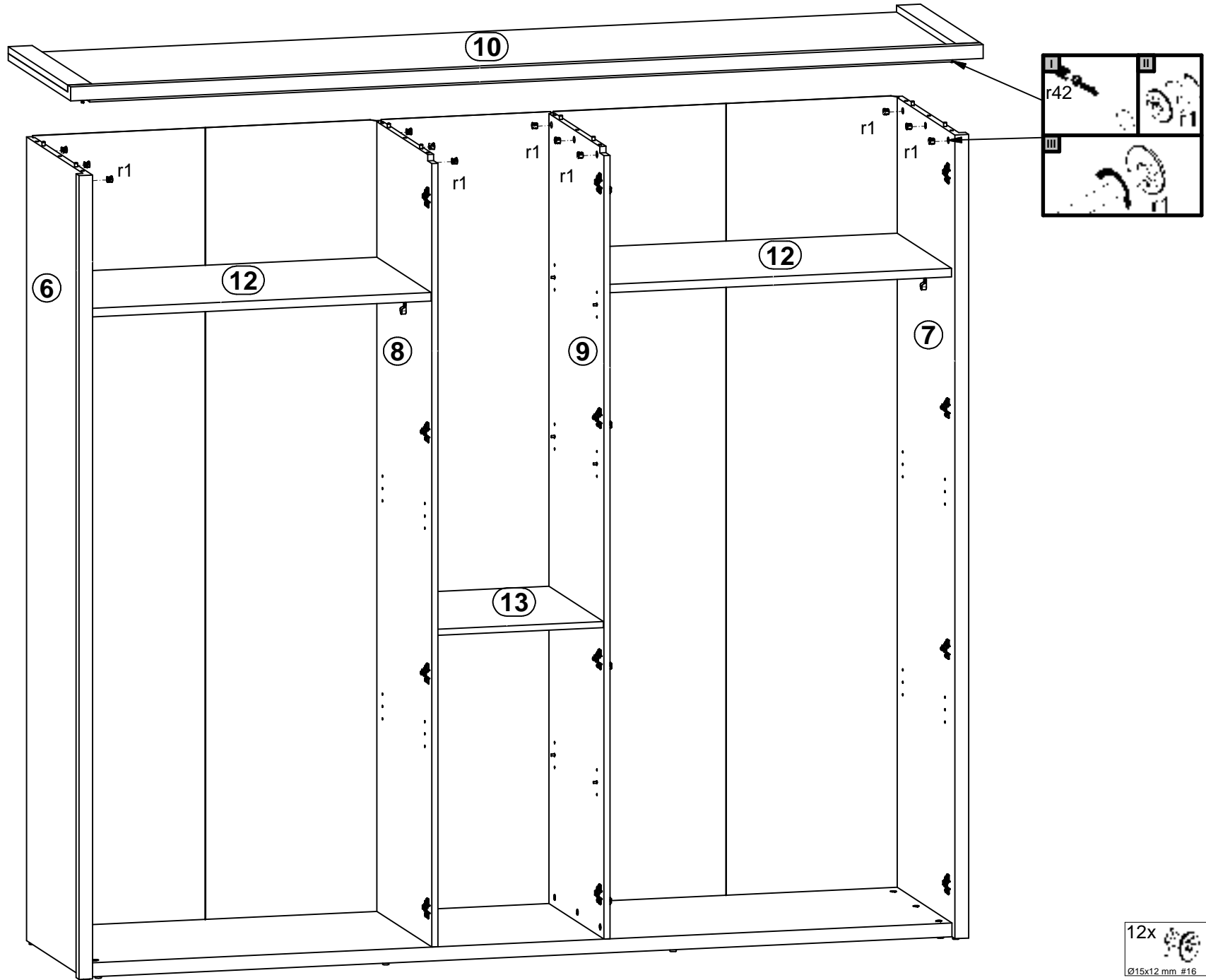



8

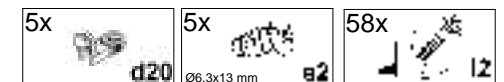
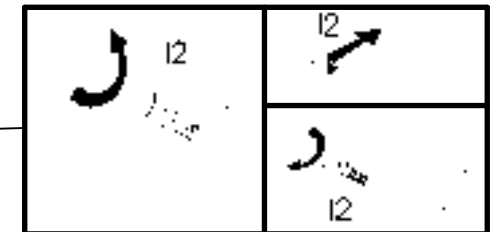
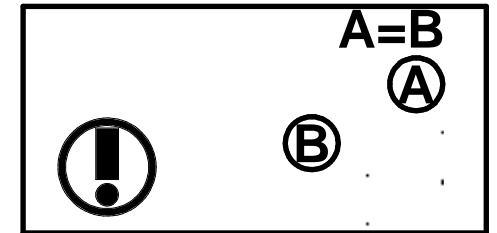
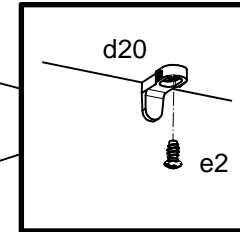
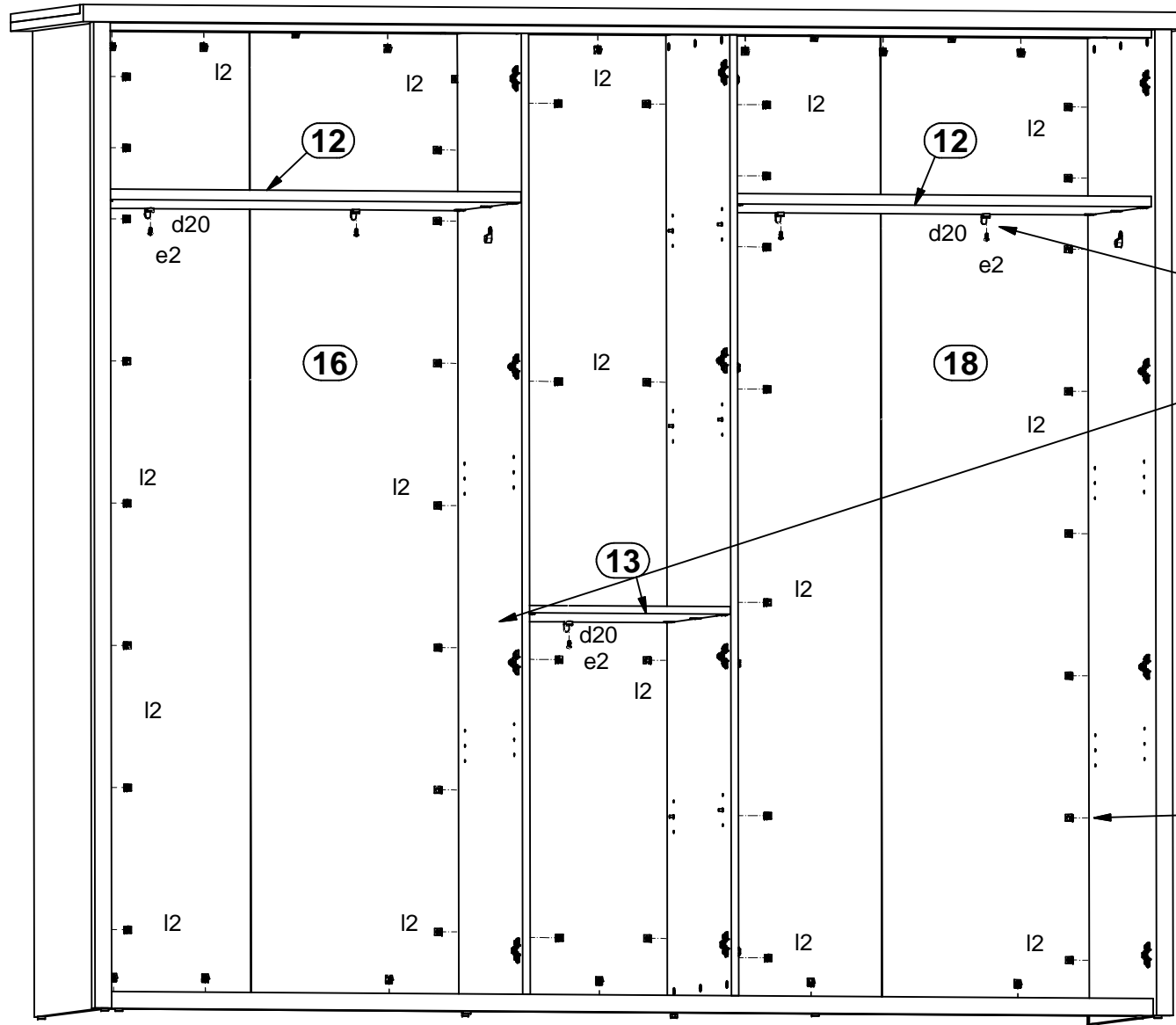

# 9

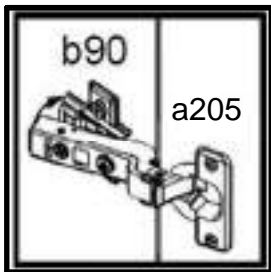
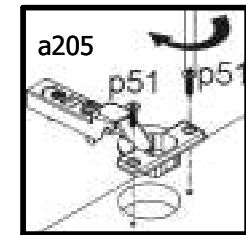
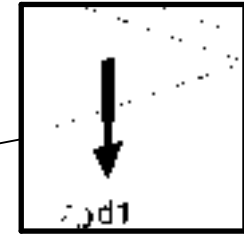
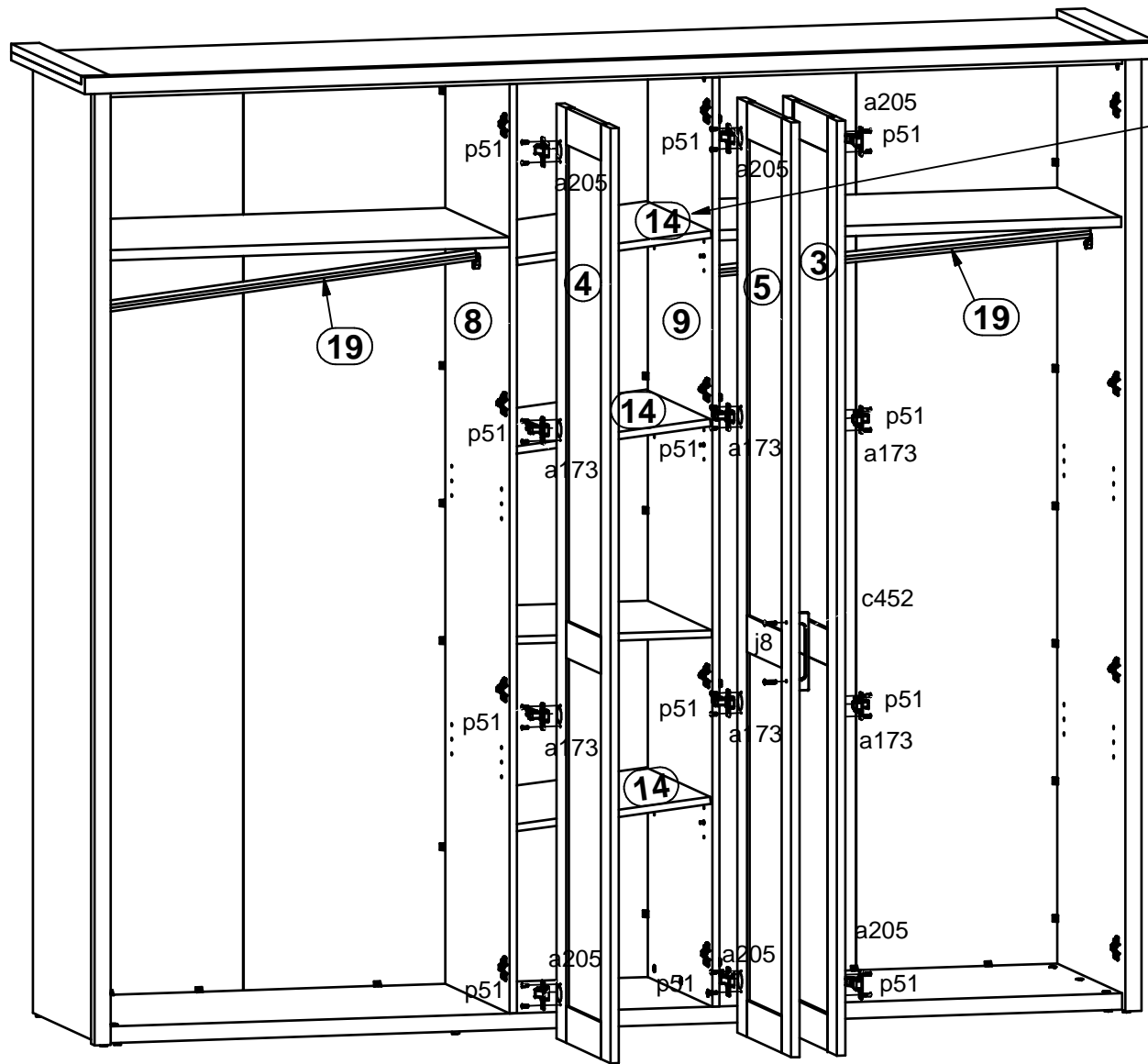

- |                      |                      |                      |                    |                          |
|----------------------|----------------------|----------------------|--------------------|--------------------------|
| 1x<br>128 mm<br>c452 | 2x<br>M4x25 mm<br>i8 | 6x<br>K9 Ø35<br>a173 | 6x<br>Ø3,5<br>a205 | 24x<br>Ø3,5x15 mm<br>p51 |
|----------------------|----------------------|----------------------|--------------------|--------------------------|

# 10

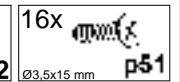
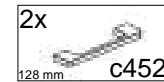
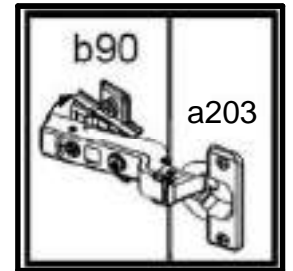
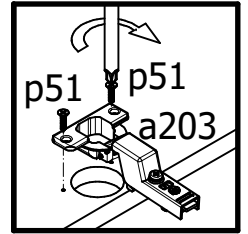
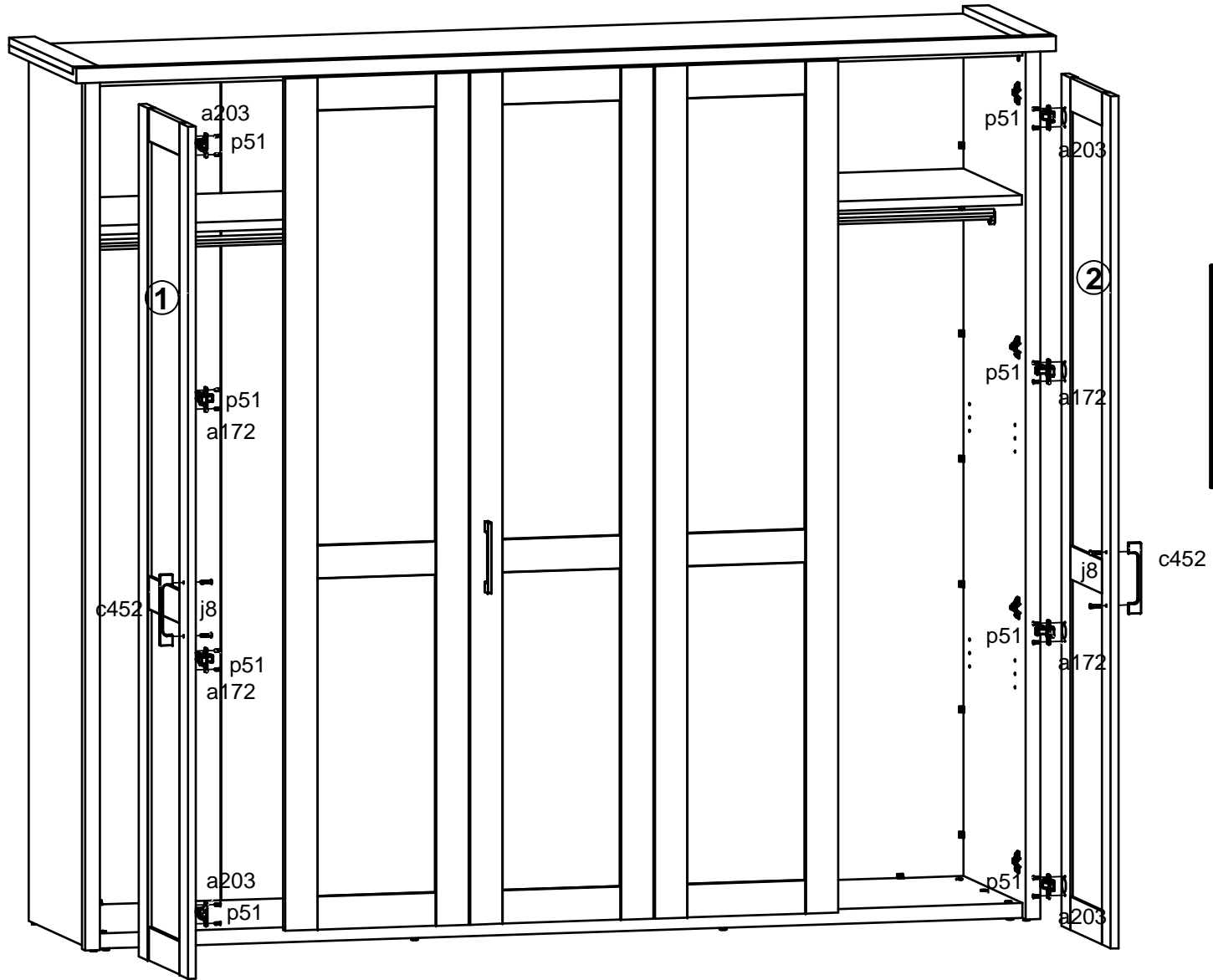

# 11

