

A

OFFICE SPACE

S479-SZF2D/200

A	B	C	D
1	S479-0003	1959	377 3/3
2	S479-1019	1965	369 2/3
3	S479-1020	1965	369 2/3
4	S479-2004	800	370 1/3
5	S479-2021	800	370 1/3
6	S479-3008	762	330 1/3
7	S479-9303	1975	771 2/3



A	B	C	D
8	S479-3004	762	326 1/1

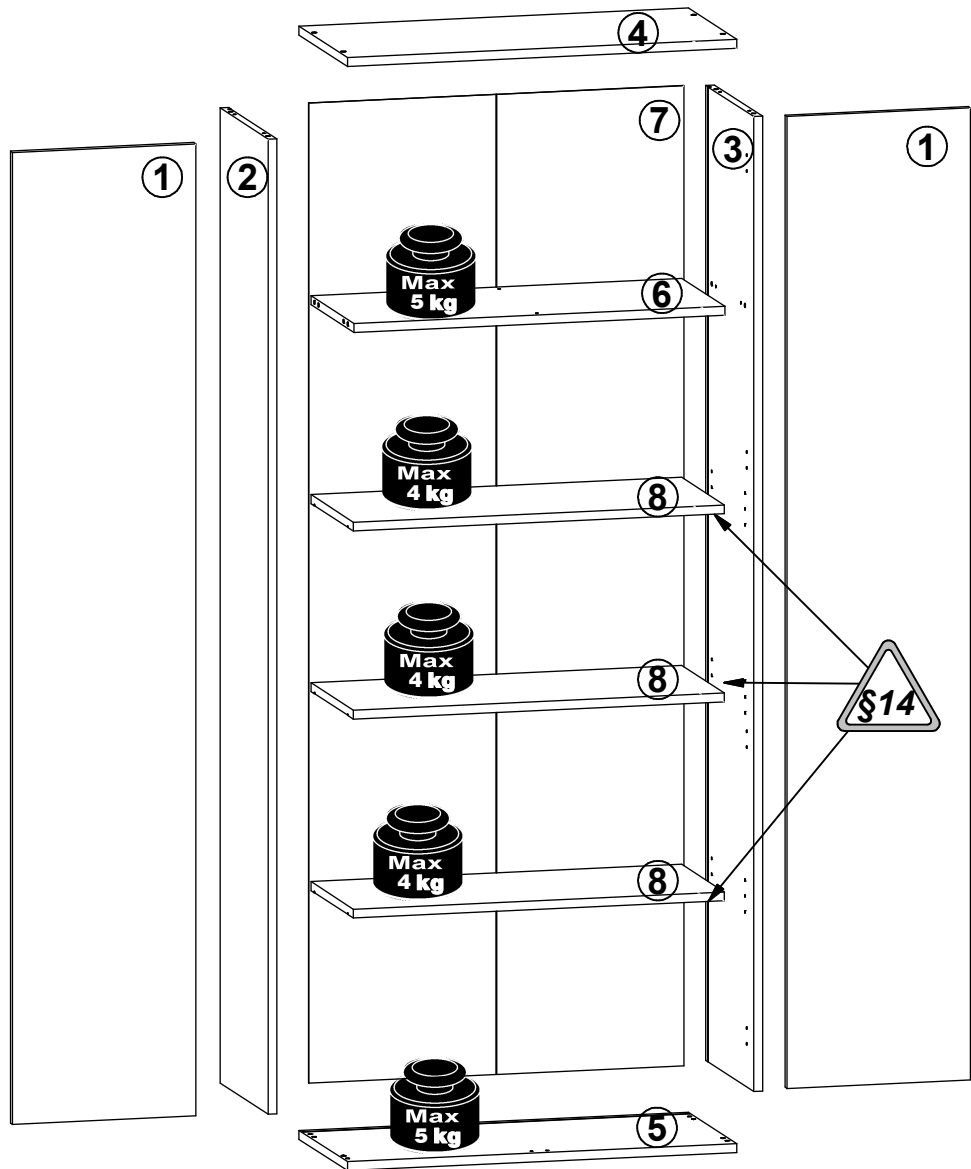
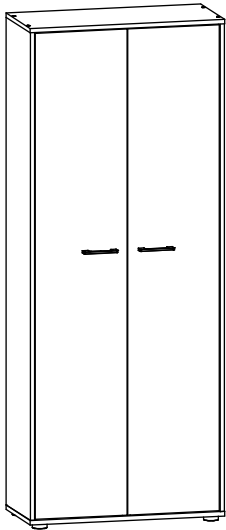
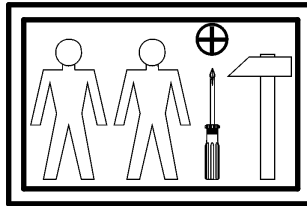

4x hamulec a203	4x a210	8x b90	2x 128mm c280	8x Ø7x50 mm e1	8x Ø6x13 mm e3	12x Ø8x30 mm f1
1x L-290x60 g76\1	4x M4x22 mm j30	2x M4x25 mm j53	4x Ø51 mm k82\1	4x Ø58,6x52 118 mm k82\4	14x l2	16x Ø3,5x15 mm p51
5x Ø2,9x16 mm p55	4x Ø15x12 mm #16 r1	4x 20/11 r42	4x Ø 20mm s68	1x 4 mm z1	1x 88x21x19\1,5 n14\2	2x Ø3,5x16 mm p38
1x Ø10x50 mm f35	1x Ø5x60 mm p17	2x Ø6,3x15 mm d4				



1 

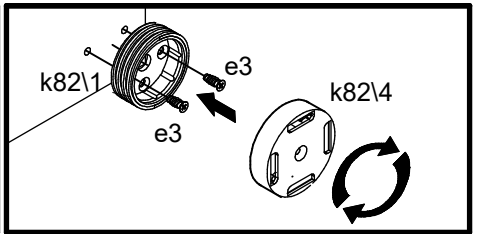
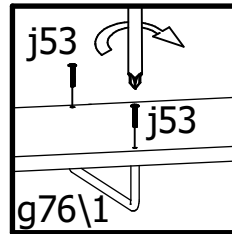
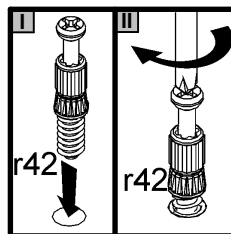
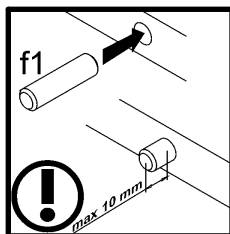
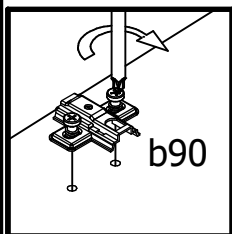
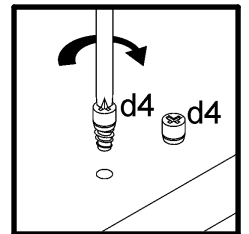
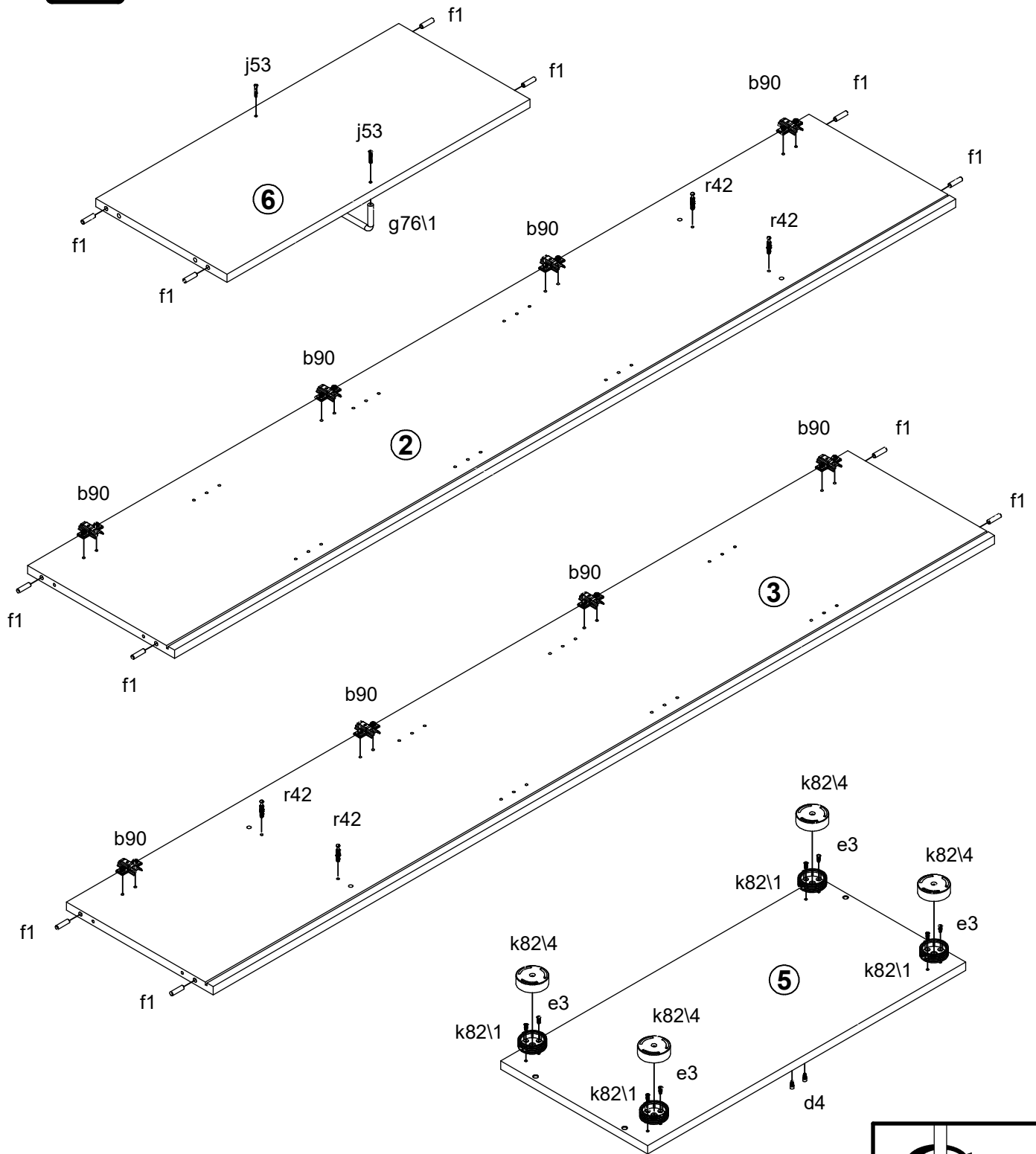

2

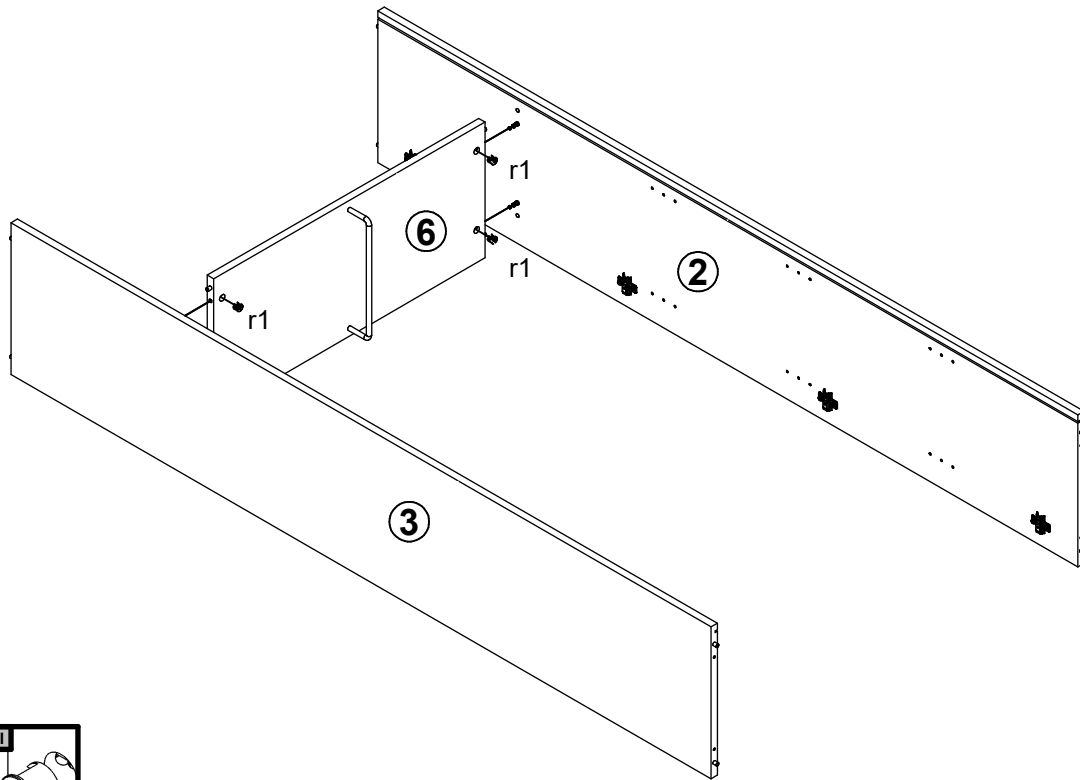

3

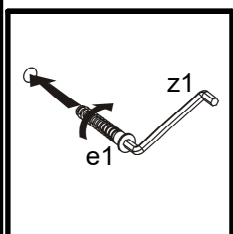
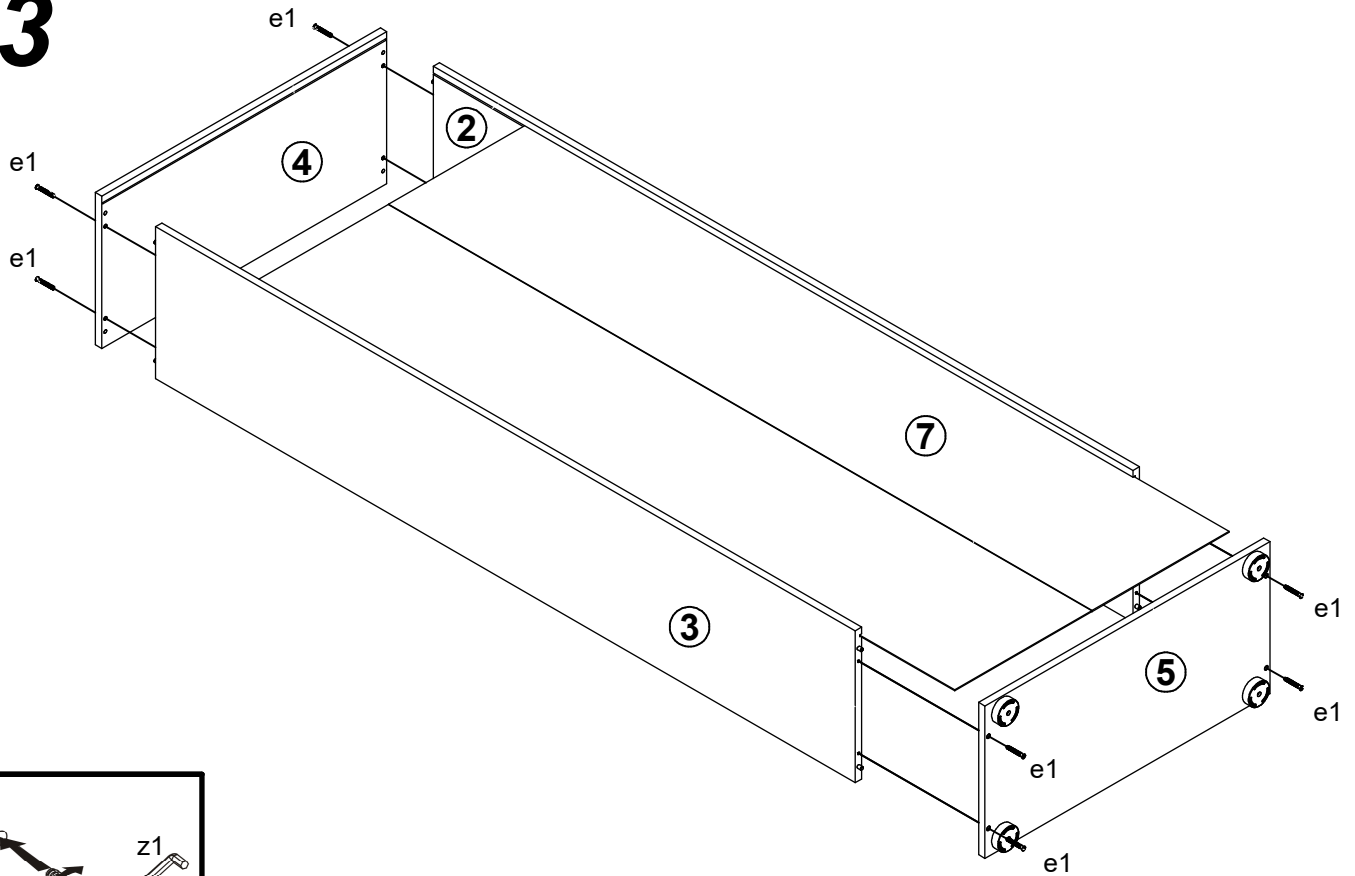

4

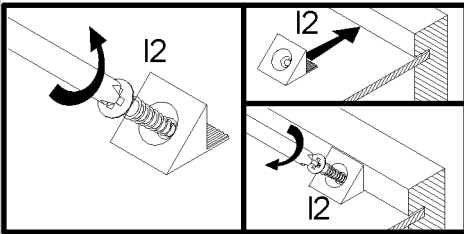
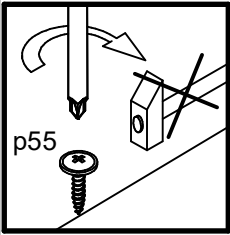
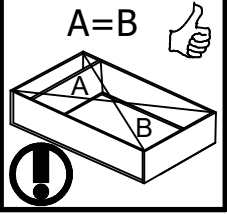
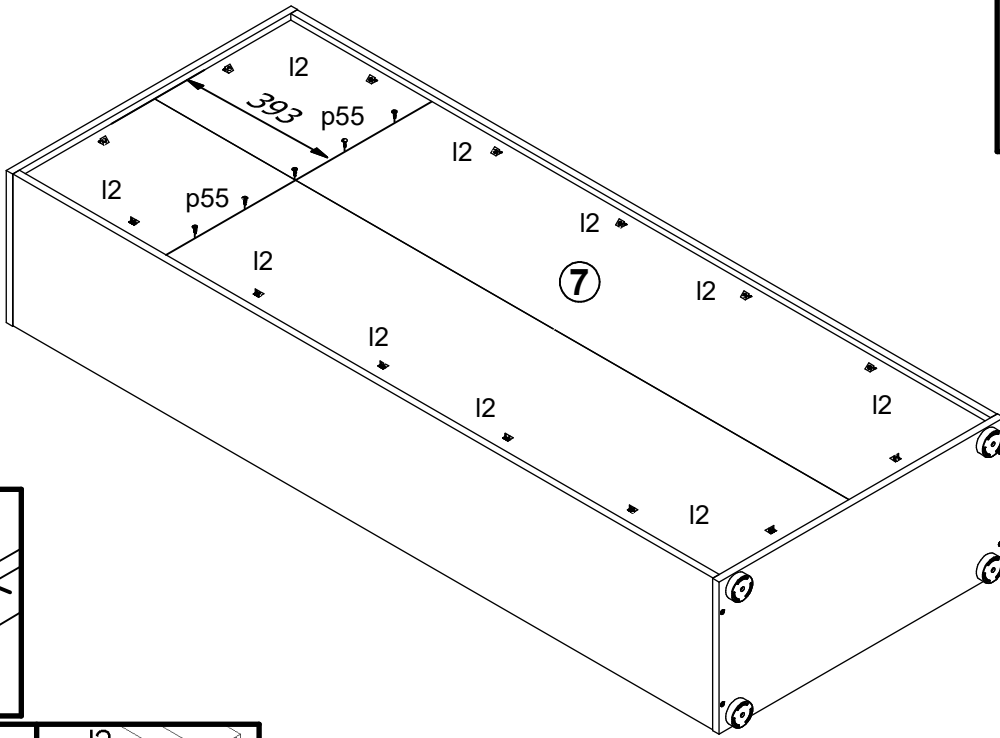

5

