

A	B	C	D
1	S435-1049	1079, 380,	1/3
2	S435-1050	1079, 380,	1/3
3	S435-1051	1056, 380,	1/3
4	S435-2019	1140, 381,	2/3
5	S435-3034	354 379	3/3
6	S435-3035	1095, 380,	2/3
7	S435-9018	1093 369	1/3
8	S435-9019	1093 380	1/3

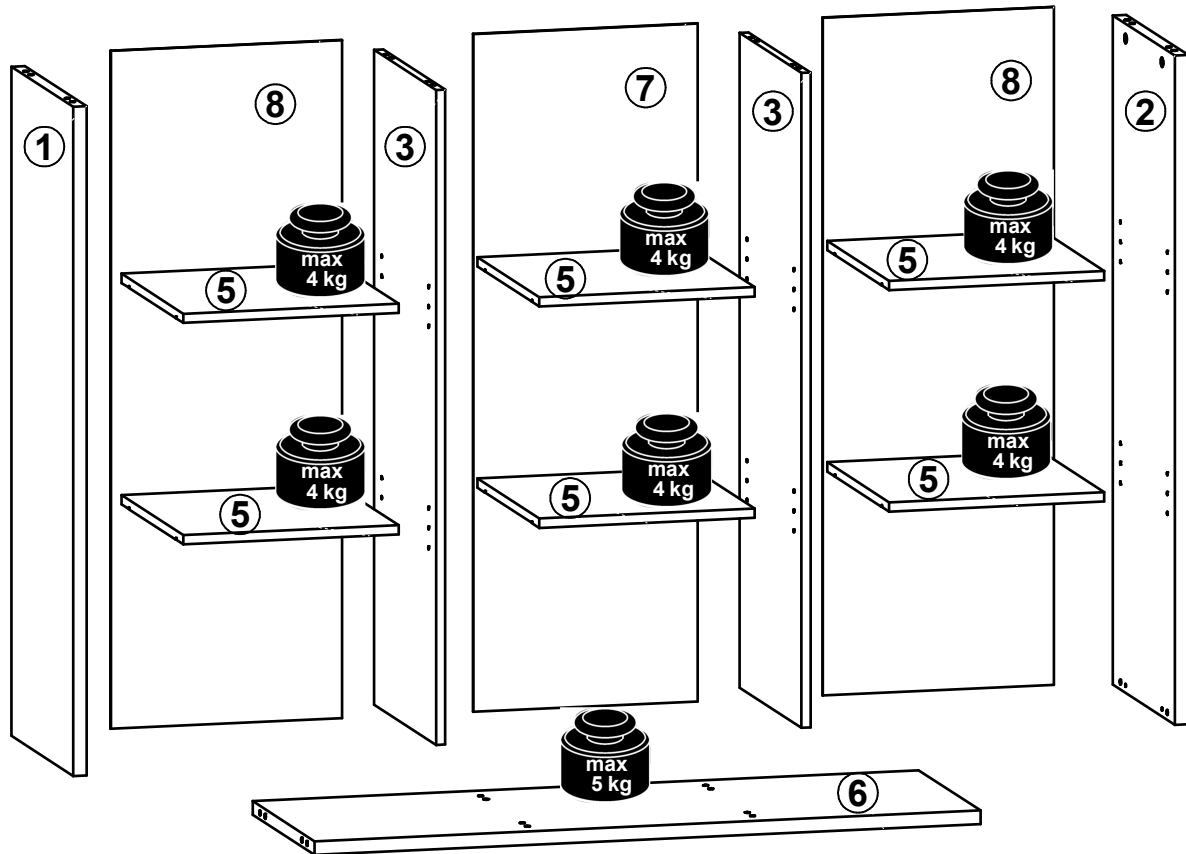

24x Ø5x17 mm d1	4x Ø7x50 mm e1	16x Ø8x30 mm f1	6x k1	90x 1.4x20 mm l1	12x Ø15x12 mm #16 r1	12x 20/11 r42	4x Ø16 s2	4x Ø15 s51
1x 4 mm z1	1x n26/1	1x Ø3.5x16 mm p38						

1 

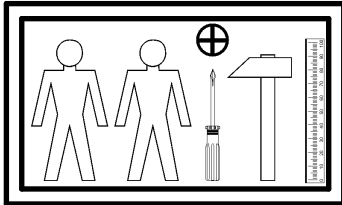
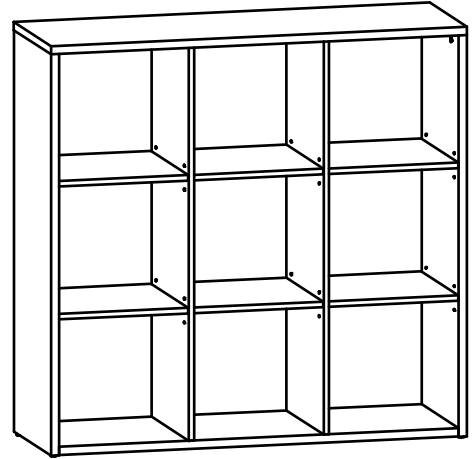
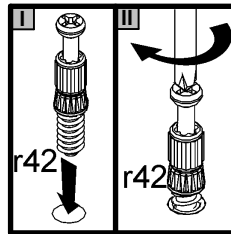
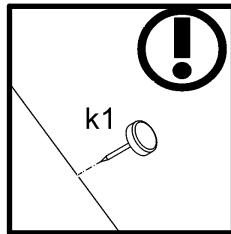
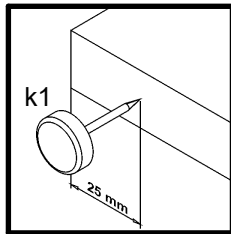
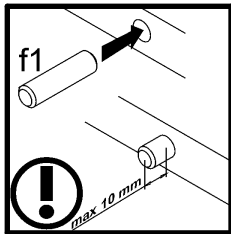
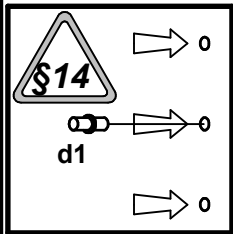
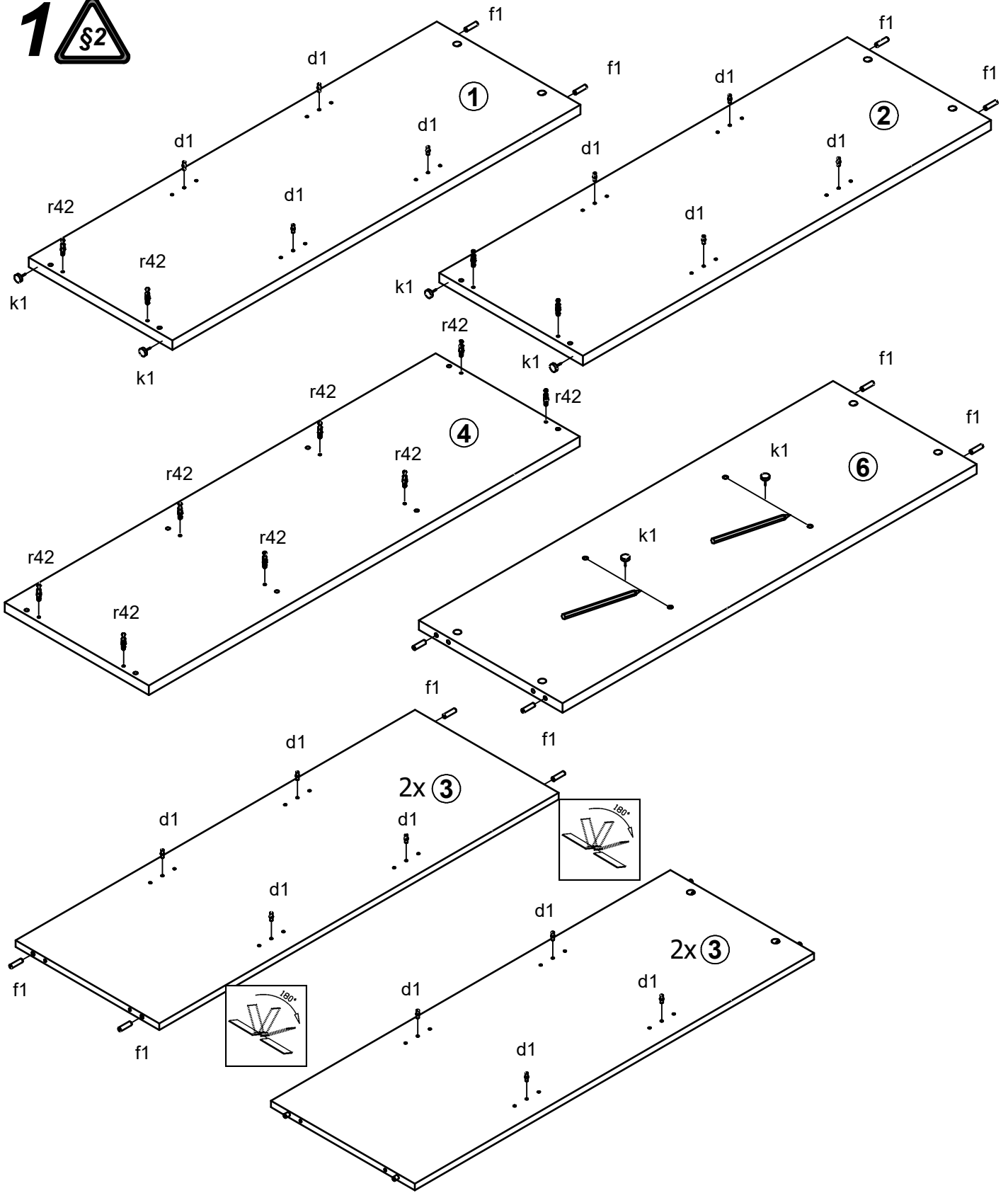

2

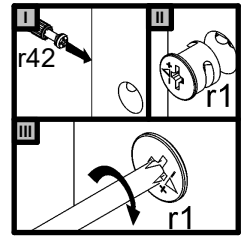
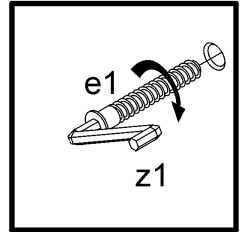
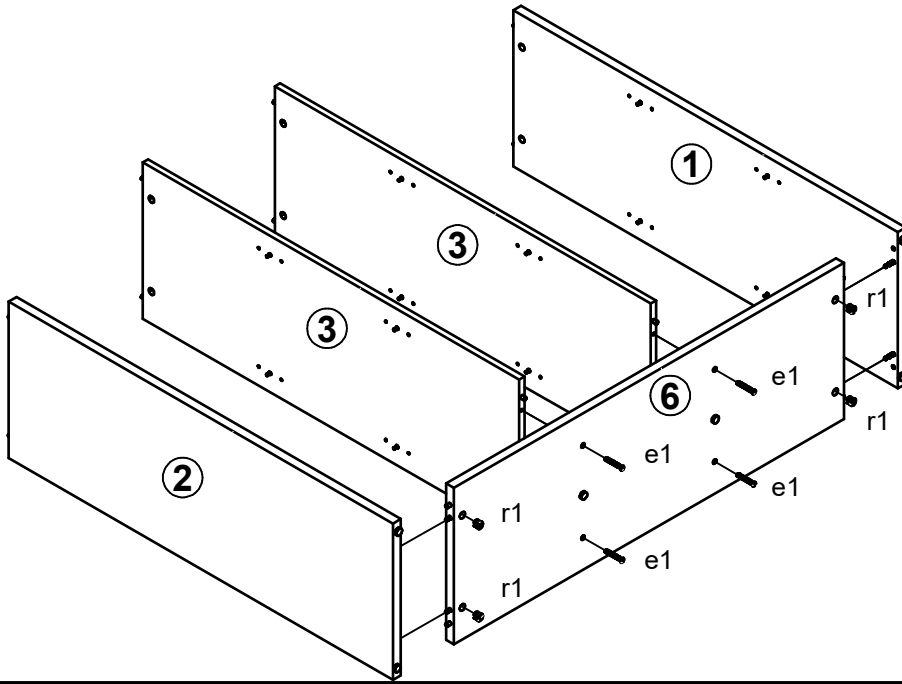

3

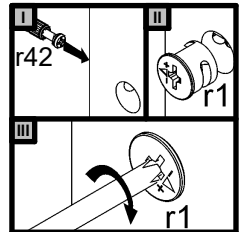
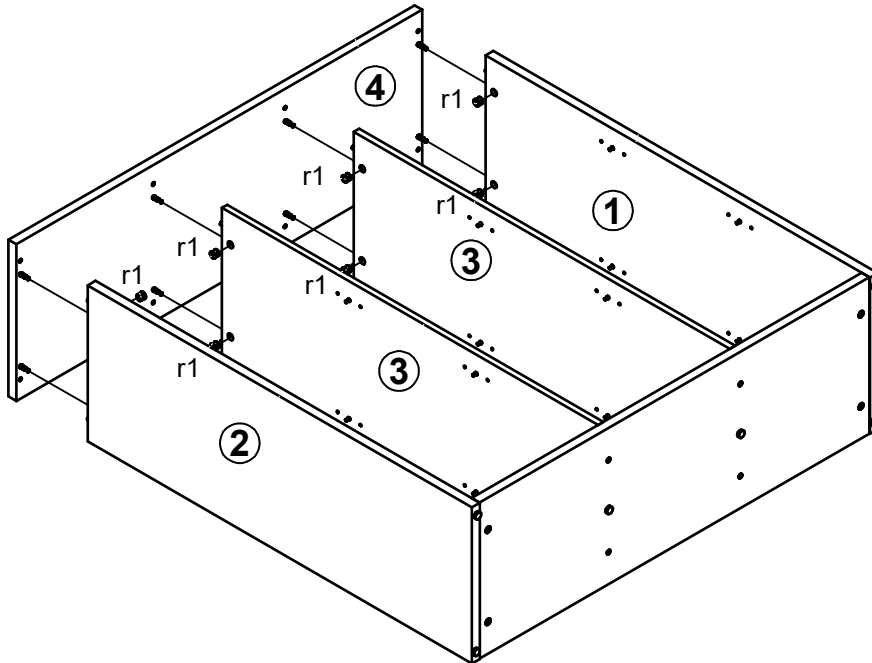

4

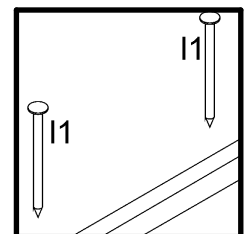
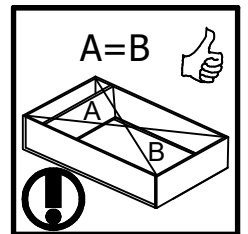
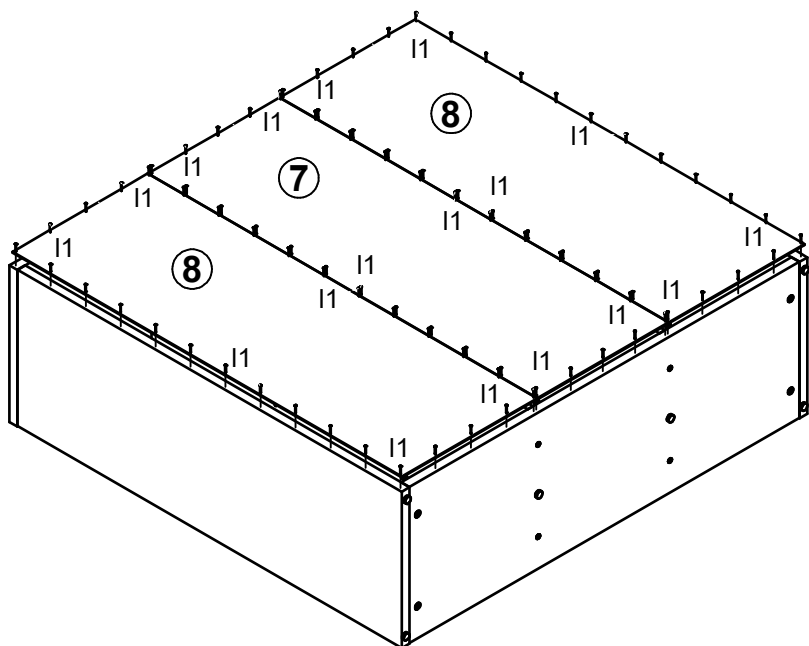

5

