

# MATRAS RECBK.2F

WS M6x20



A x 8



A1 x 4

h:100



E x 4

h:100



E1 x 4

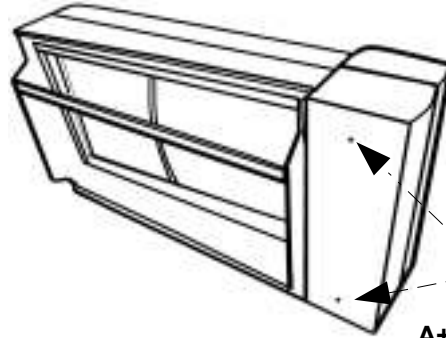
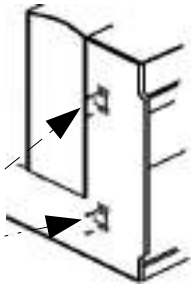
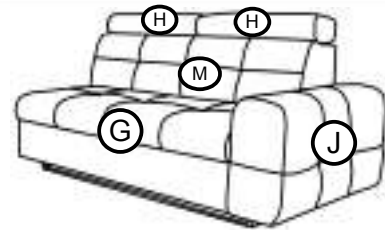
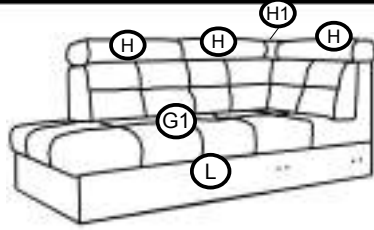

A+A1

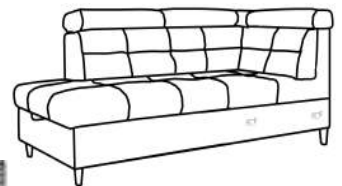
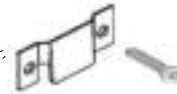
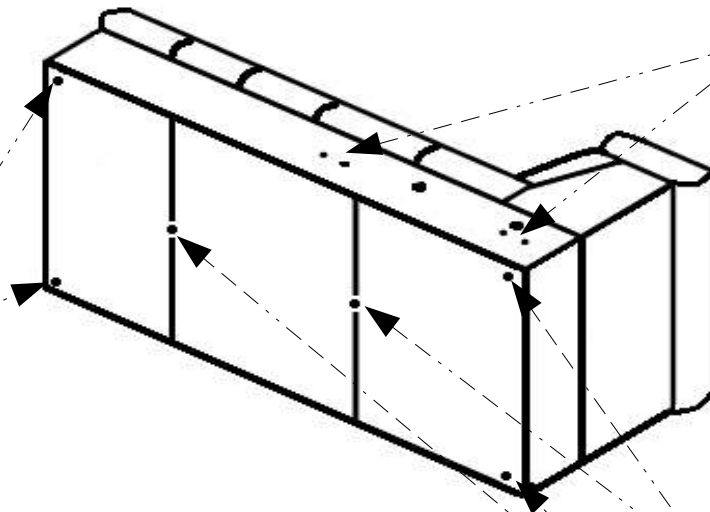
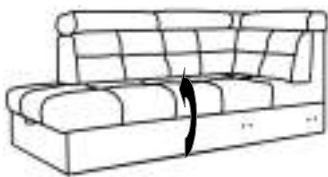

A+A1

E1

A	H
A1	H1
E	J
E1	M
G	
G1	
G2	



