

A	B	C	D						
1	S305-021	446	196	4/4	12	S305-532	692	80	3/4
2	S305-022	446	100	4/4	13	S305-510	400	60	2/4
3	S305-130	1142	403	1/4	14	S305-511	400	60	2/4
4	S305-131	1142	403	1/4	15	S305-914	1099	685	1/4
5	S305-132	1067	403	1/4	16	S305-915	426	405	3/4
6	S305-133	1067	403	1/4	17	ZS3-5584	404	140	2/4
7	S305-209	691	403	2/4	18	ZS3-5585	404	60	2/4
8	S305-316	660	403	2/4	19	ZS4-527	400	140	2/4
9	S305-528	1142	120	2/4	20	ZS4-528	400	140	2/4
10	S305-529	1142	120	3/4					
11	S305-429	453	56	2/4					

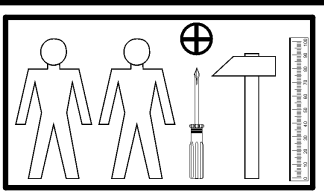

4x Ø7x50 mm e1	20x Ø5x9 mm e19	30x Ø6x13 mm e3	44x Ø8x30 mm f1	20x Ø6.5x40 mm f25	8x Ø6x30 mm f9	4x k1	45x l1	20x Ø3.5x16 mm p38
30x Ø15x12 mm #16 r1	20x Ø12x10.5 mm #12 r15	46x r42	2x r51	5x 400 mm w5\CL	5x 400 mm w5\CR	5x 400 mm w5\DL	5x 400 mm w5\DR	1x z1
1x n26\1	1x Ø3.5x16 mm p38							

1 

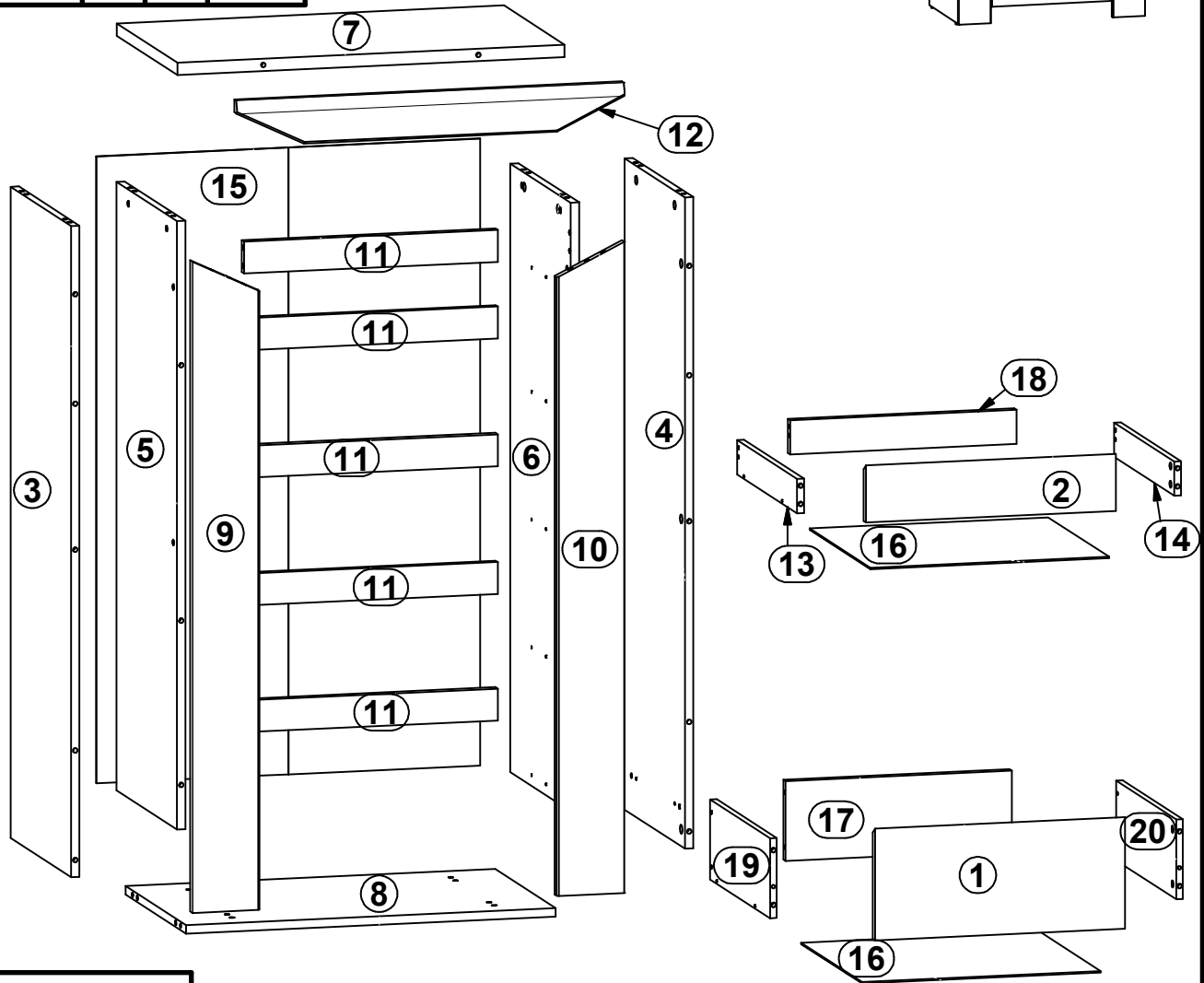
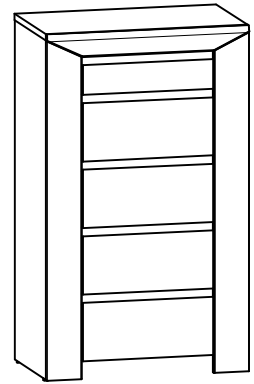
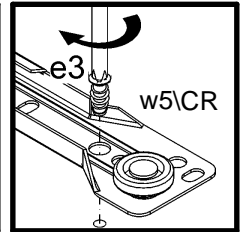
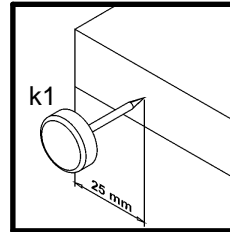
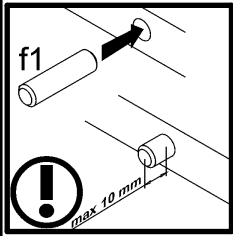
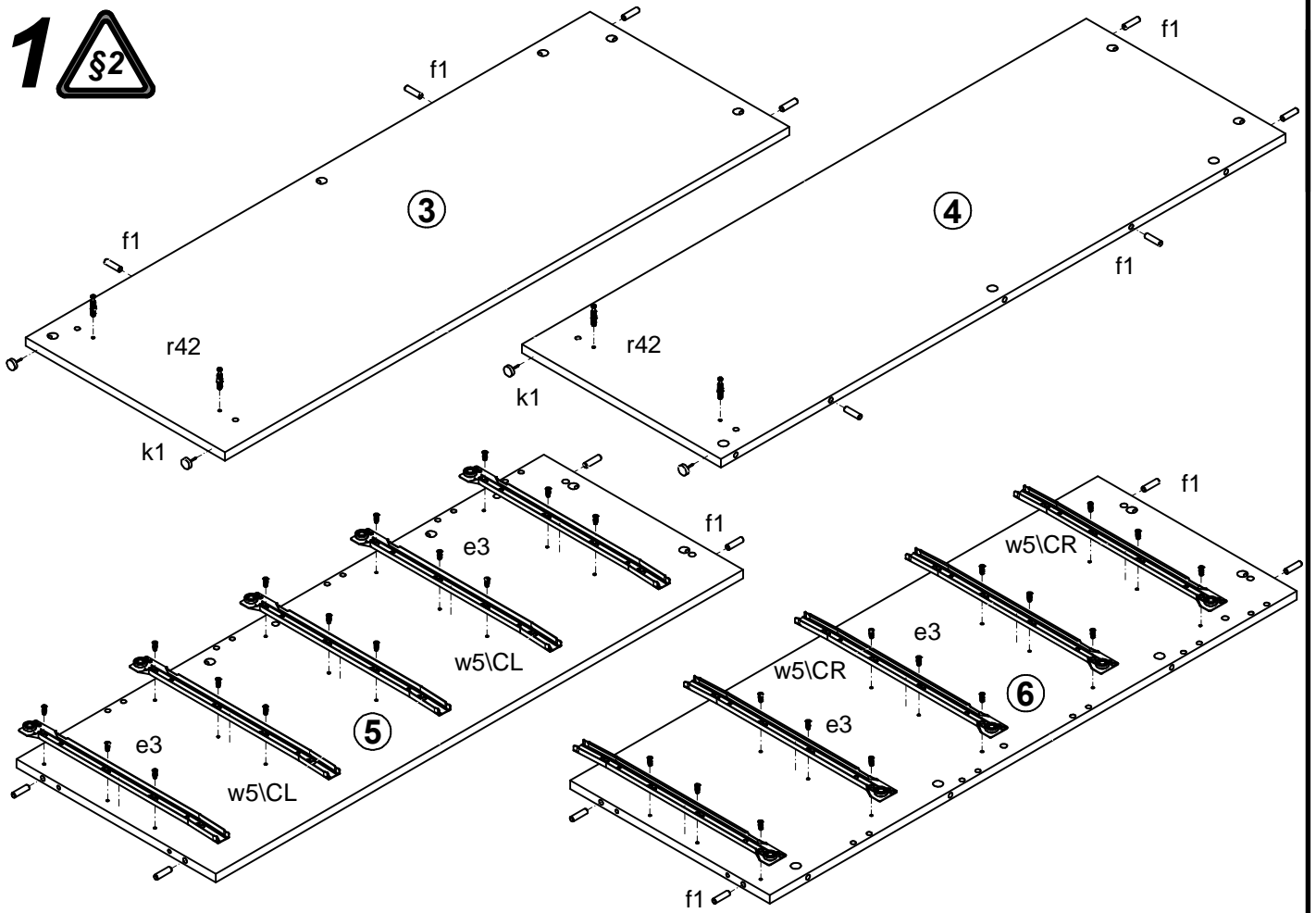

2 

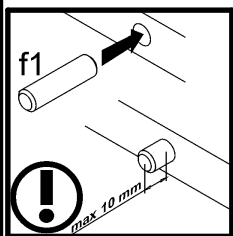
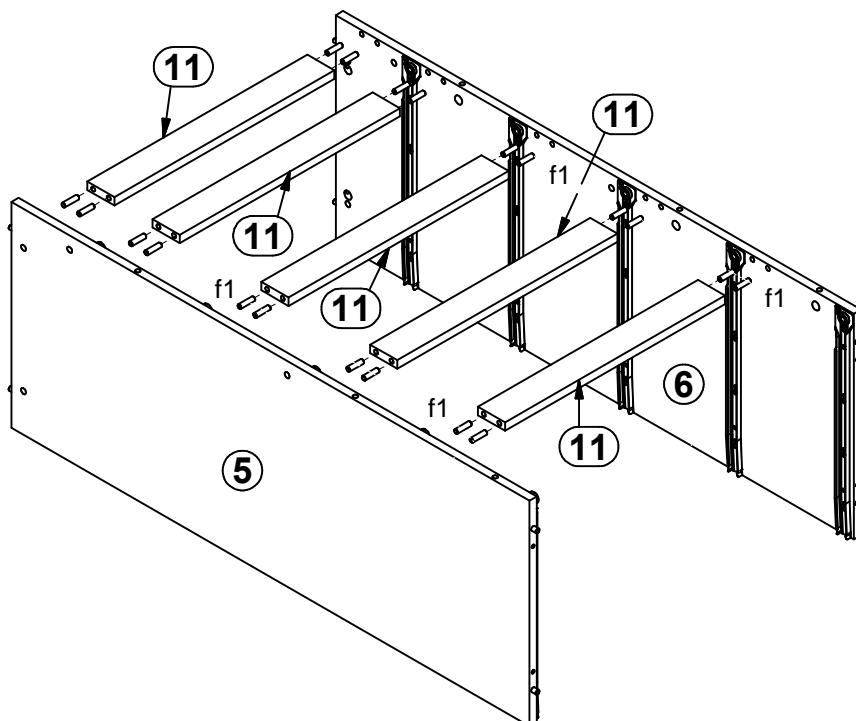

3

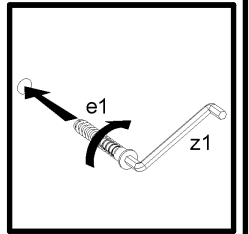
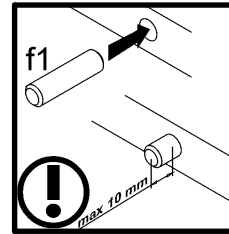
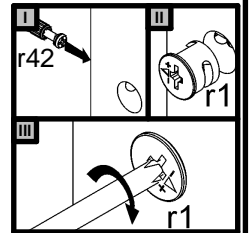
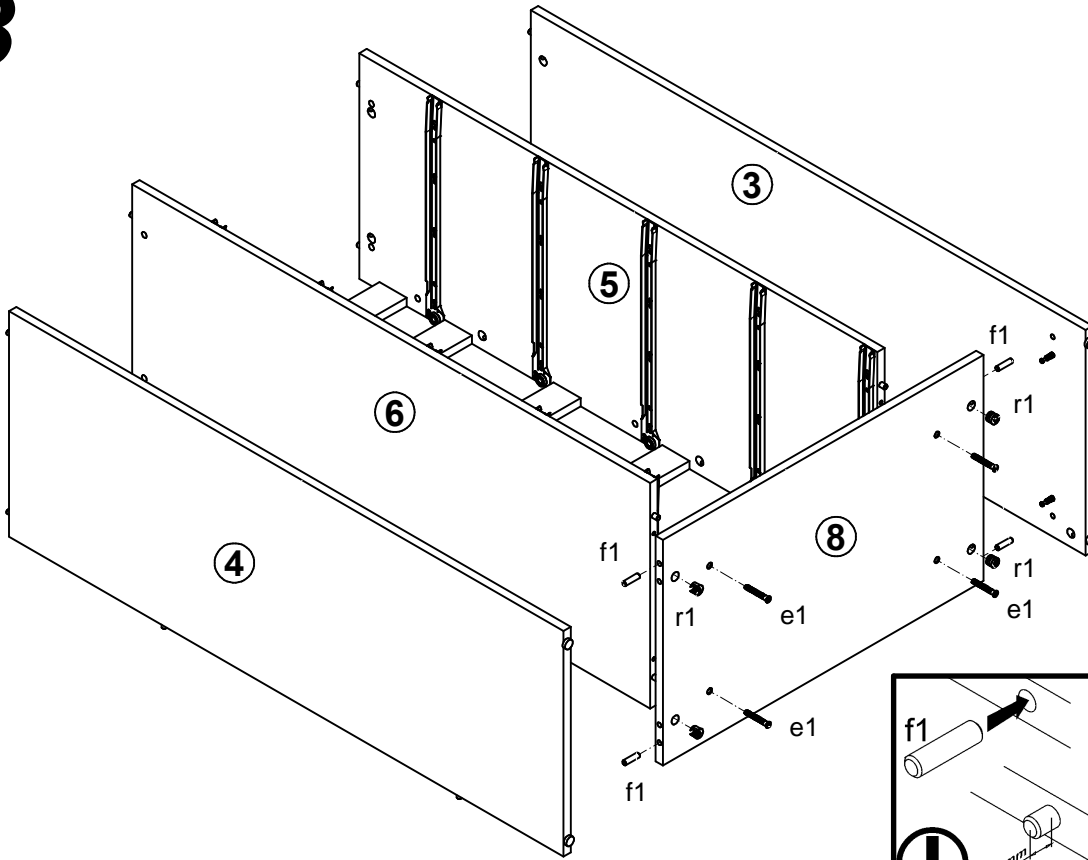

4

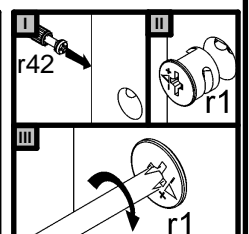
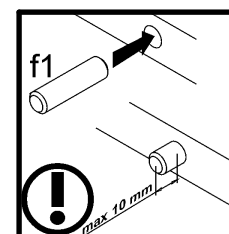
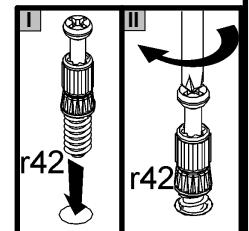
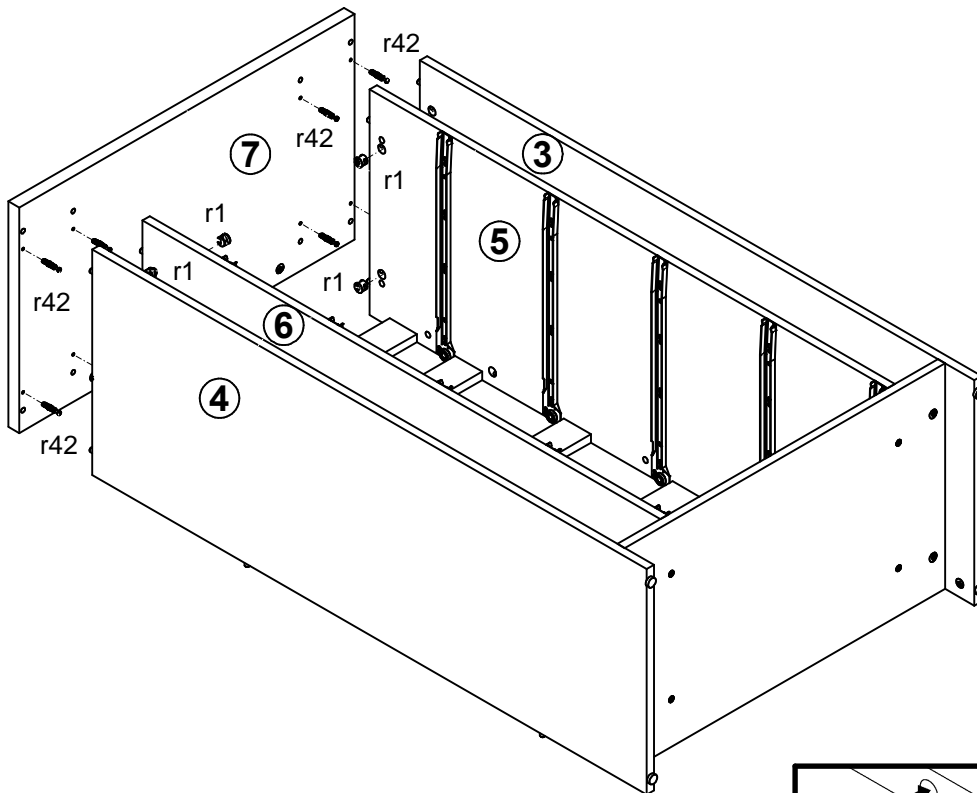

5

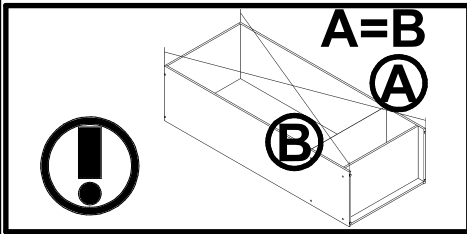
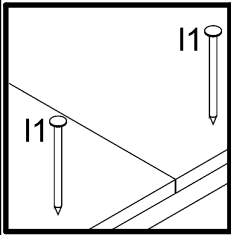
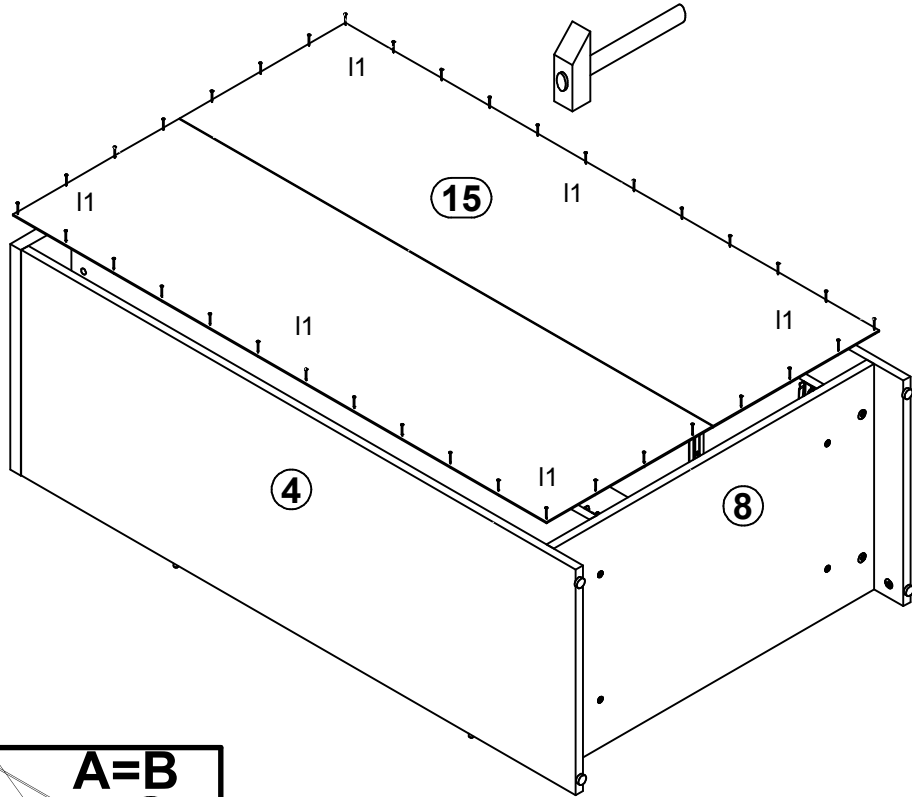

6

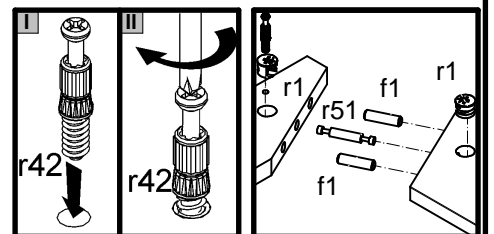
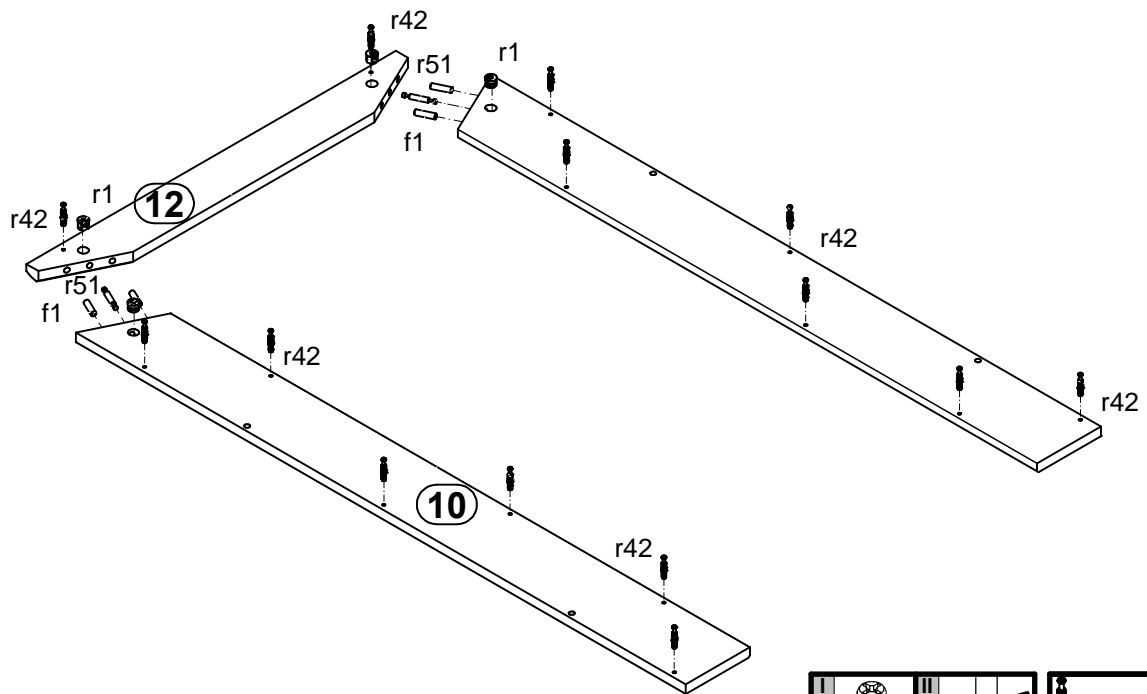

7

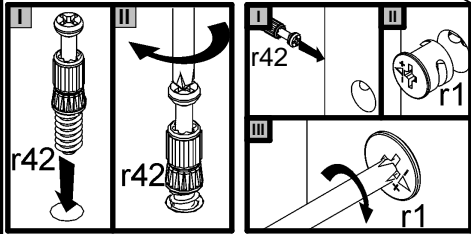
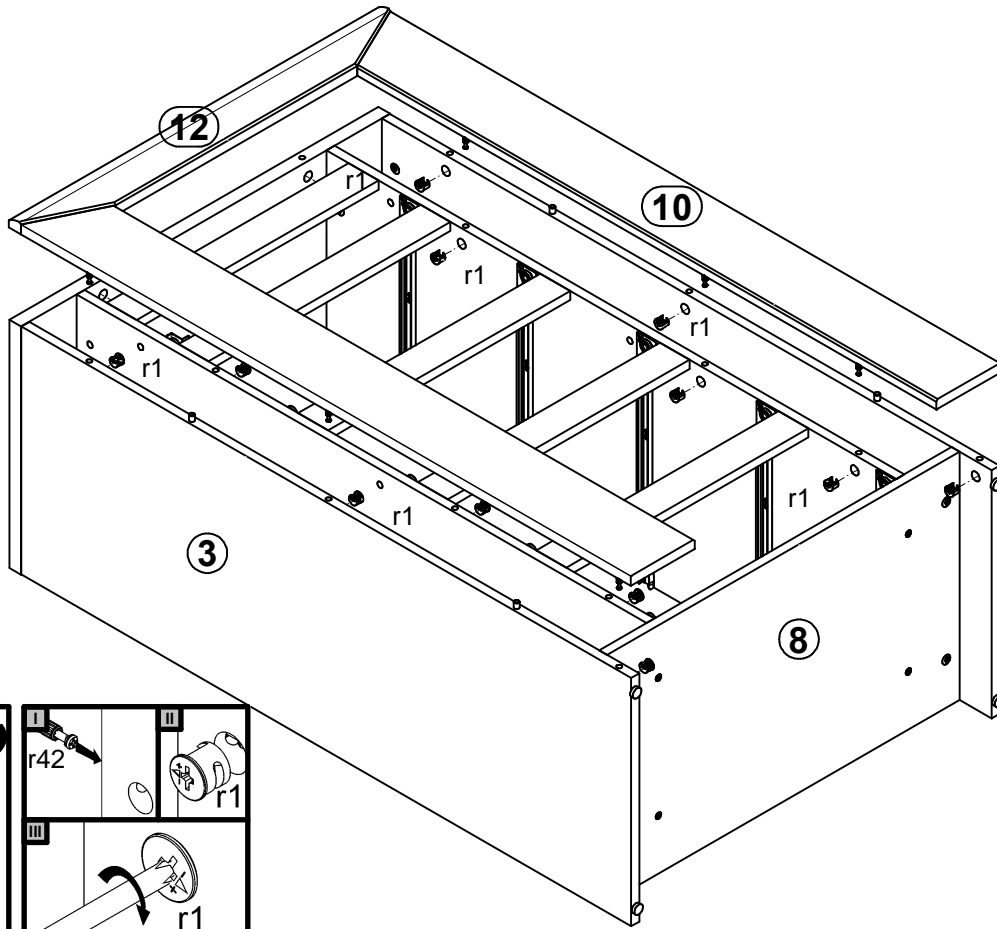

8

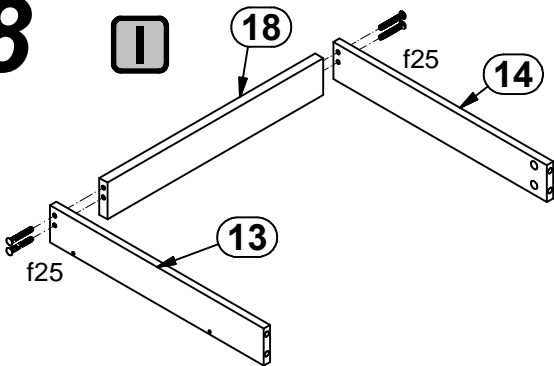
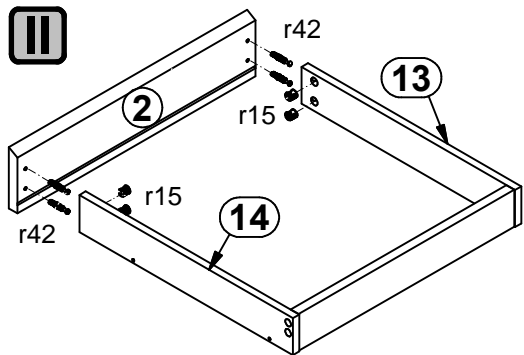
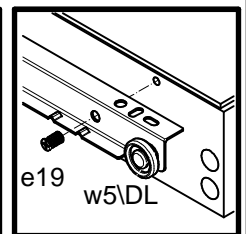
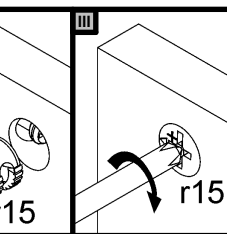
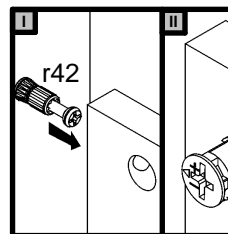
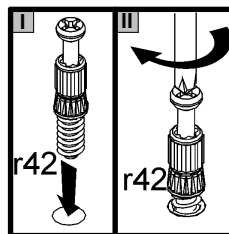
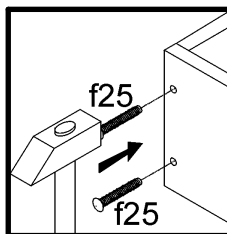
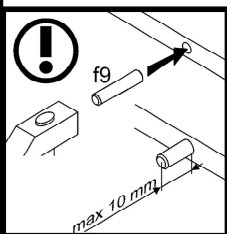
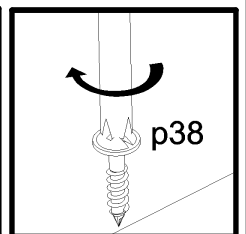
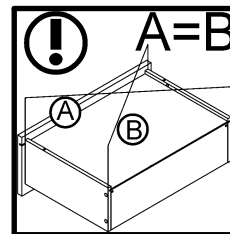
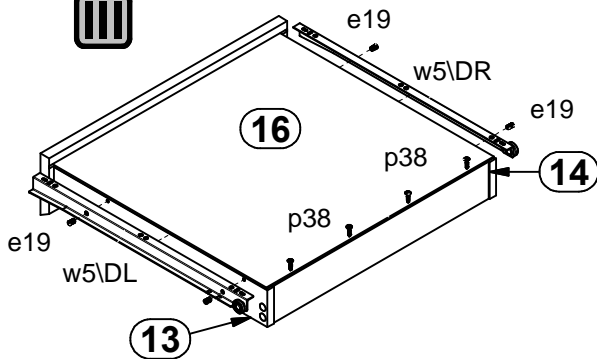
I**II****III**

9

I

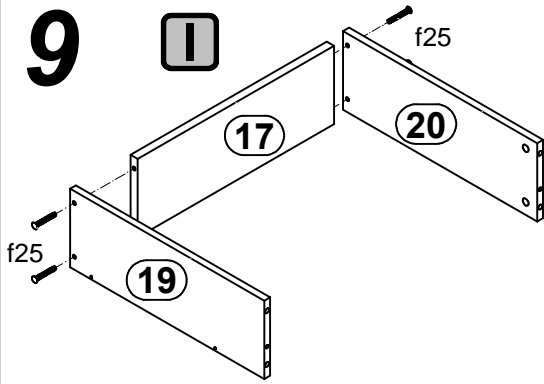

II

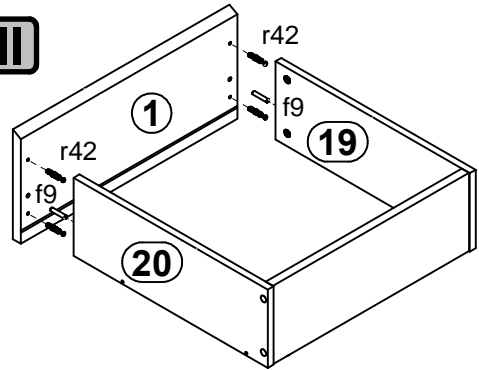

III

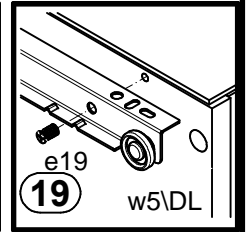
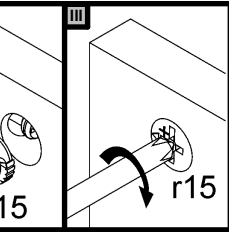
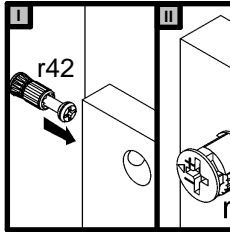
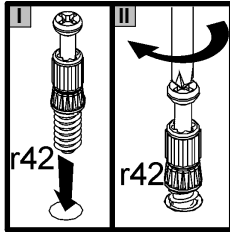
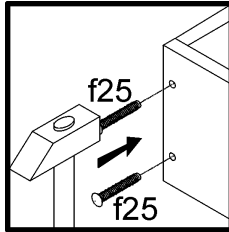
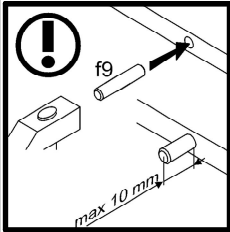
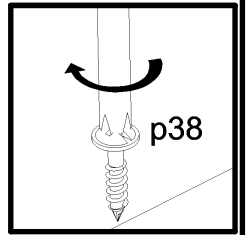
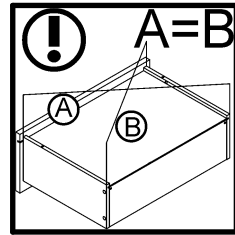
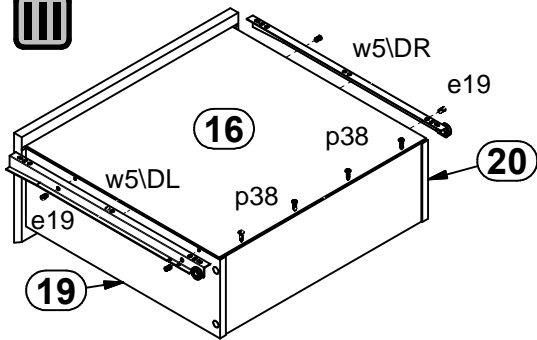

10

