

A	B	C	D	
1	L99-1007	2180	580	1/7
2	L99-1008	2180	551	1/7
3	L99-1009	2179	535	2/7
4	L99-1010	2179	535	2/7
5	L99-3003	827	535	4/7
6	L99-3004	979	535	4/7
7	L99-3005	827	480	3/7
8	L99-3006	979	480	3/7
9	L99-3009	827	535	4/7
10	L99-3010	979	535	4/7
11	L99-4010	827	51	3/7
12	L99-4011	979	51	3/7
13	L99-4012	827	51	3/7
14	L99-4013	979	51	3/7
15	L99-7006	2130	145	7/7
16	L99-7007	2130	145	7/7
17	L99-7010	1074	733	6/7
18	L99-7011	1074	733	6/7
19	L99-7012	1074	332	7/7
20	L99-9301	2108	837	1/7
21	L99-9302	2108	987	2/7
22	dr-821x30	821	30	5/7
23	dr-975	975	30	5/7
24	EG-sp 2130	2130	4,8	5/7

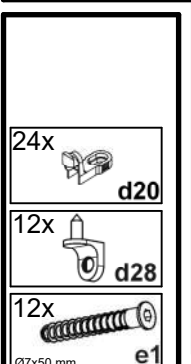
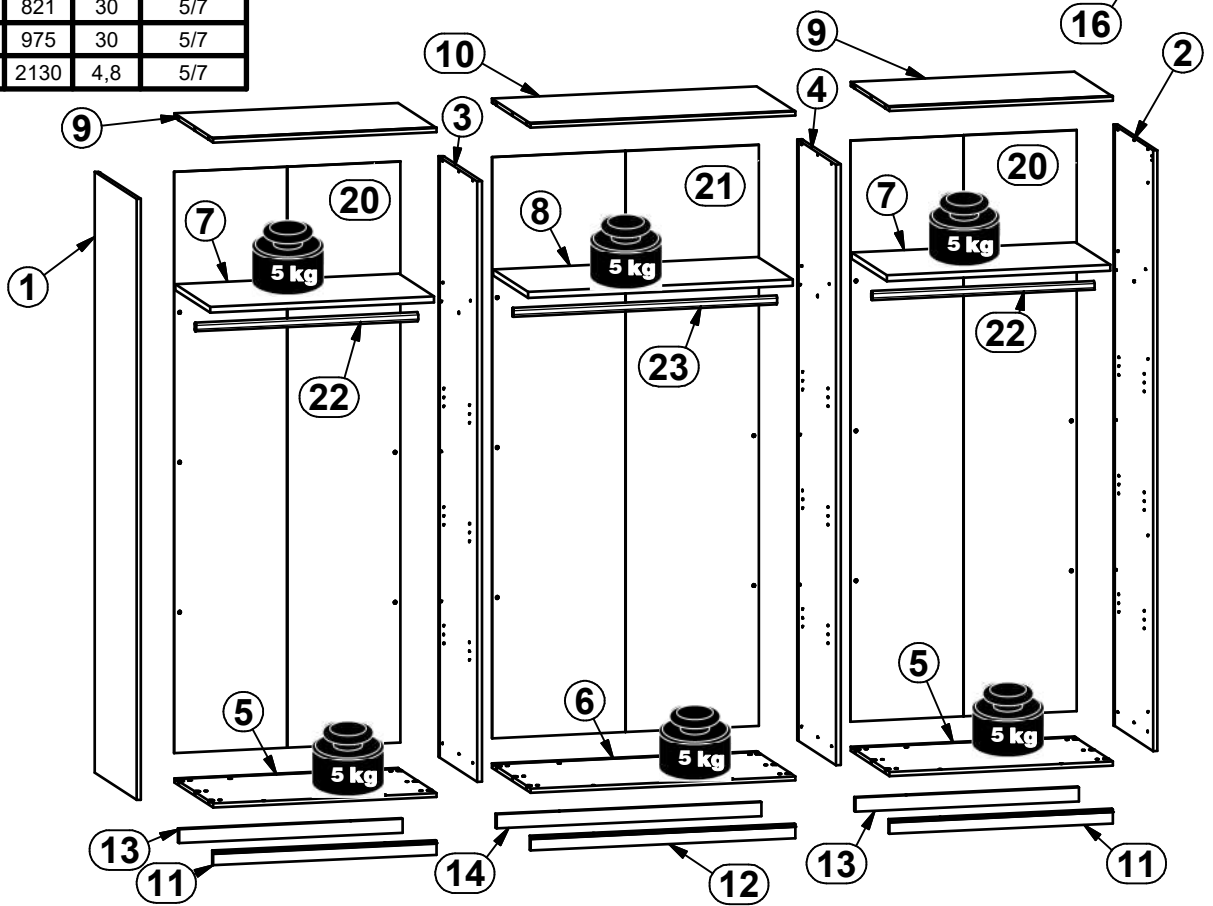
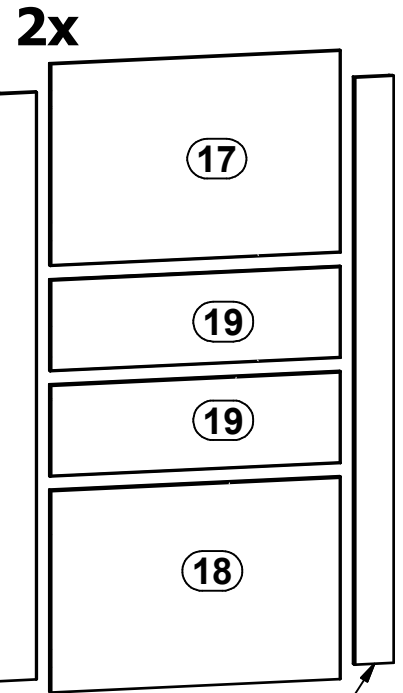
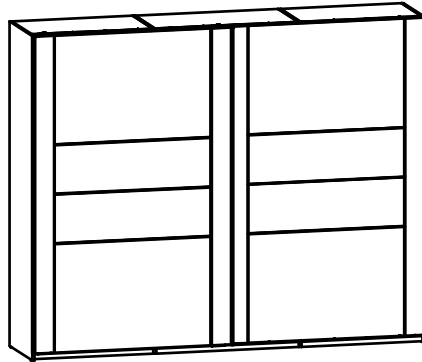

24x d20	12x d28	12x e1 Ø7x50 mm	28x e5 Ø6.3x13 mm	24x e50 Ø6.3x10 mm	12x e51 Ø6.3x10 mm	2x f20	2x f55	32x f6 Ø8x50 mm	2x j148 M5x20 mm	2x j149 M5	8x k1						
30x i2	1x n139	6x n158	18x n180 110x50/2 mm	2x n188	1x n189	2x n45	2x n46/3	6x p1 Ø3.5x13 mm	4x p16 Ø3.5x25 mm	13x p25 Ø3.5x16 mm	205x p93 Ø4x13 mm	48x r1 Ø15x12 mm #16	24x r10	36x r37 6.7/7.8	36x r54 Ø20x13.5 mm #19	1x w118/8 2130 mm	1x w123/1 2668 mm
3x w172/5 L-2130 mm	1x w175/2 L-2668 mm	12x s1	8x i63	1x z1 4 mm	4x p38 Ø3.5x16 mm	2x f35 Ø10x50 mm	2x p17 Ø5x60 mm	2x n14/2 88x21x15/1.5									

1 

2x

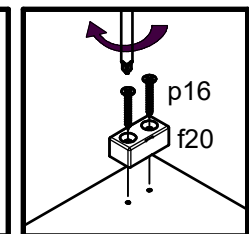
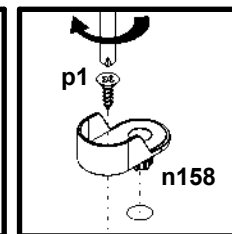
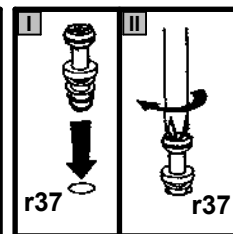
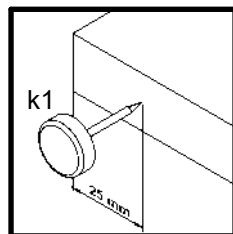
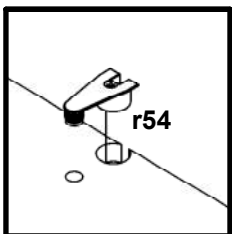
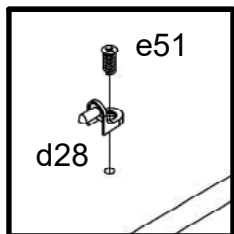
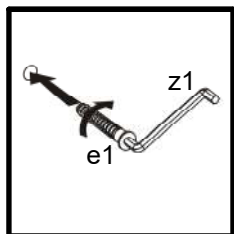
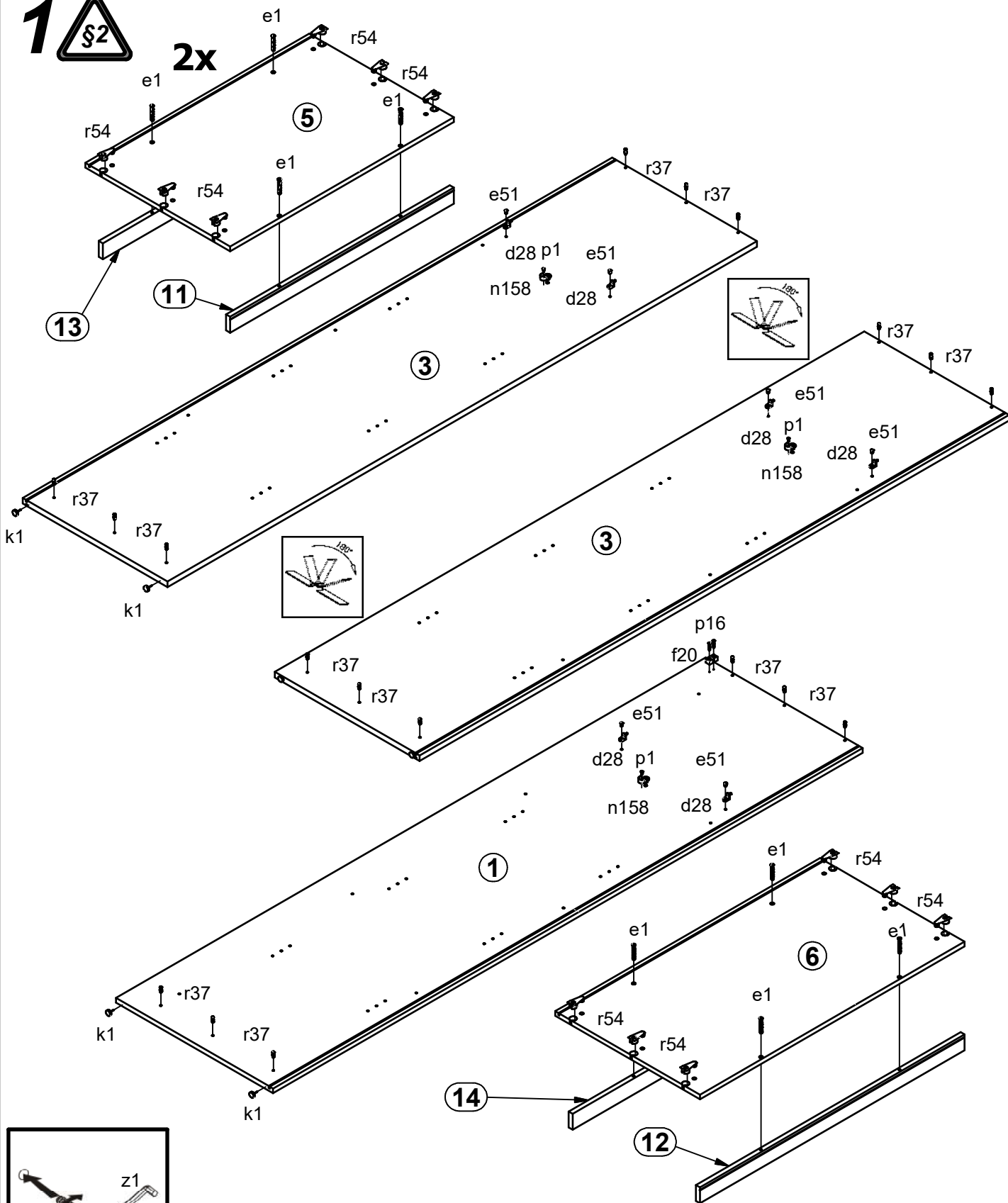

# 2

## 2x

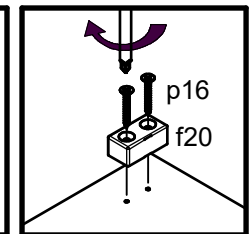
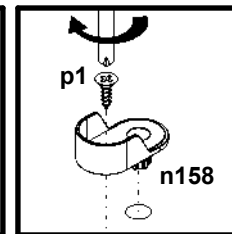
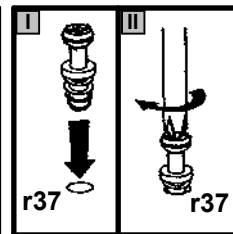
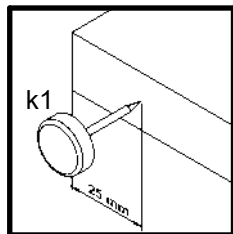
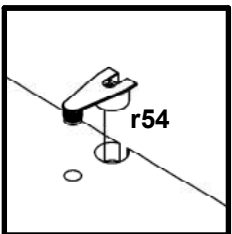
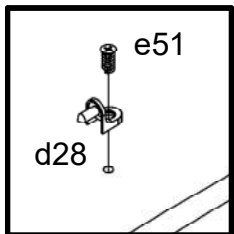
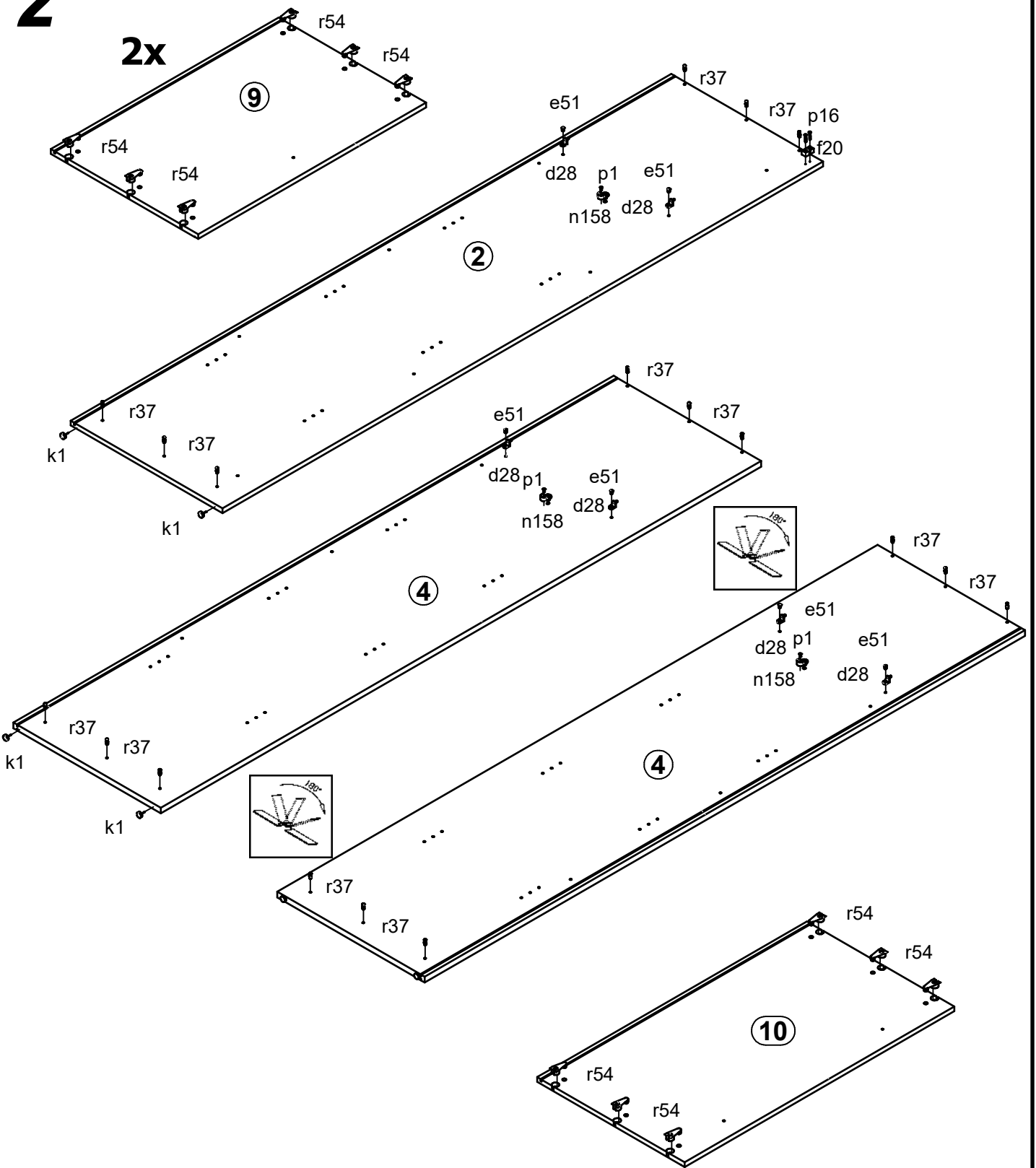

# 3

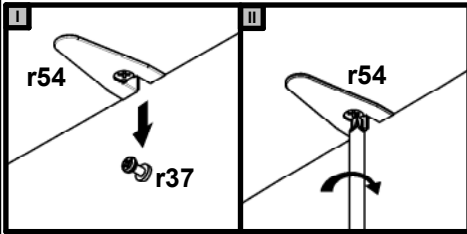
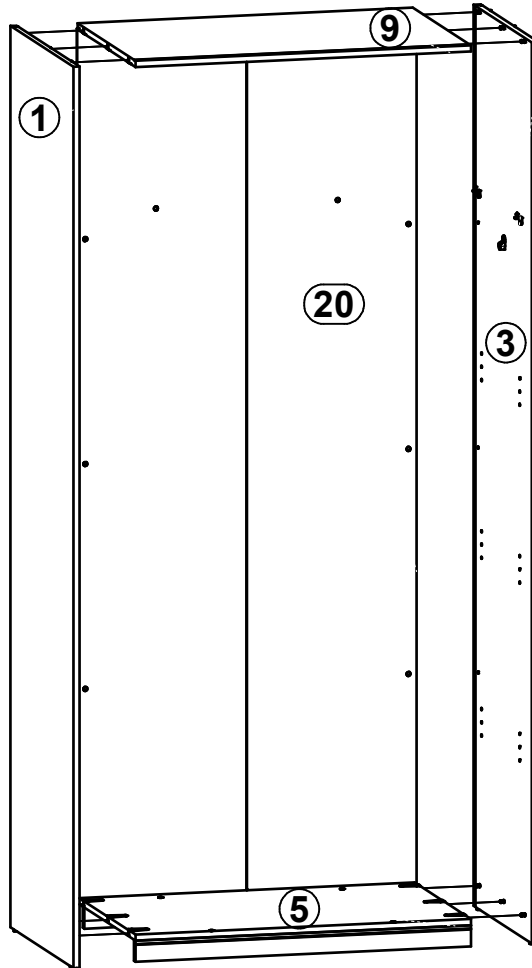

# 4

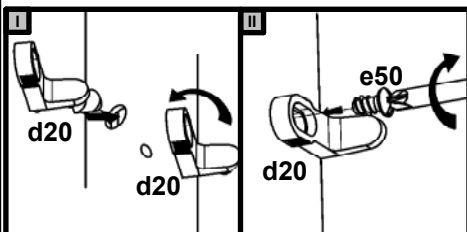
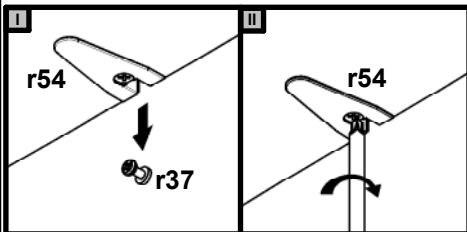
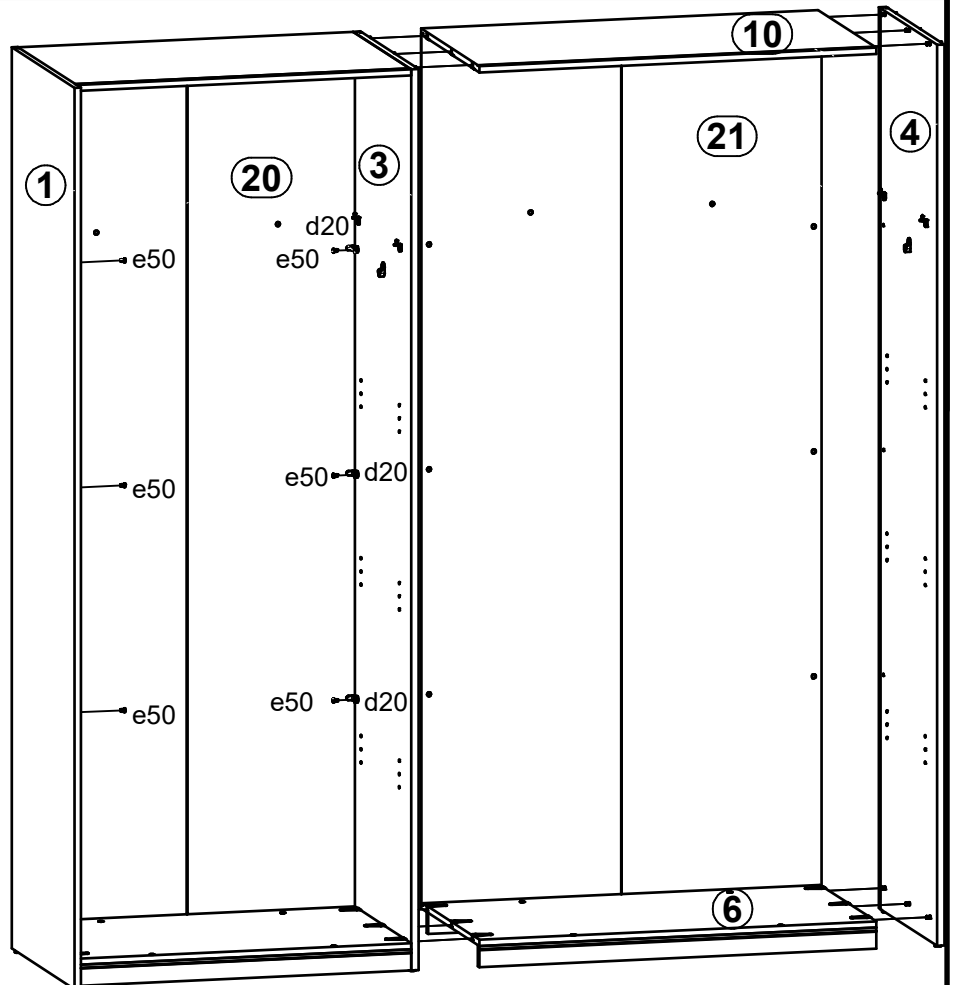

# 5

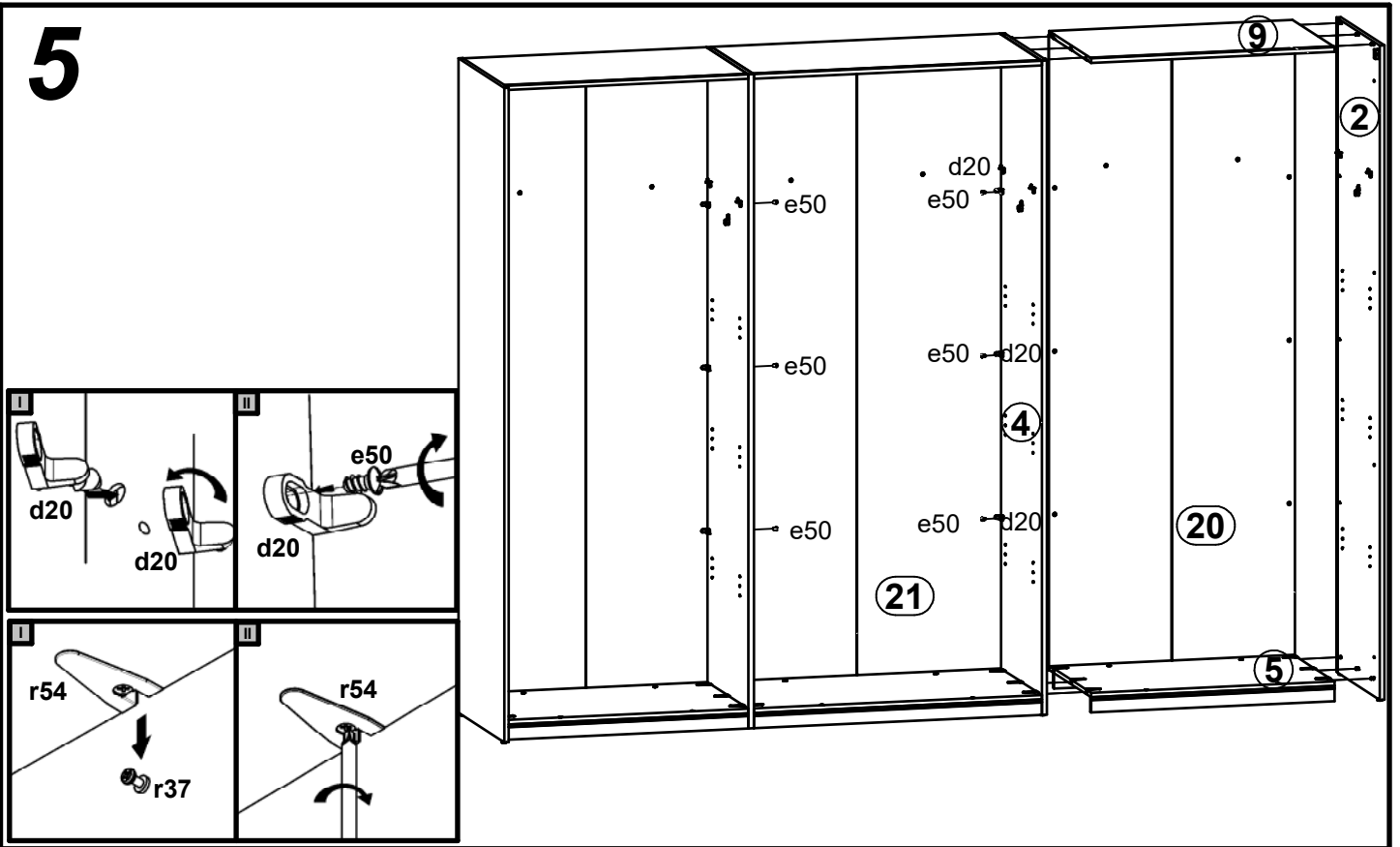

# 6

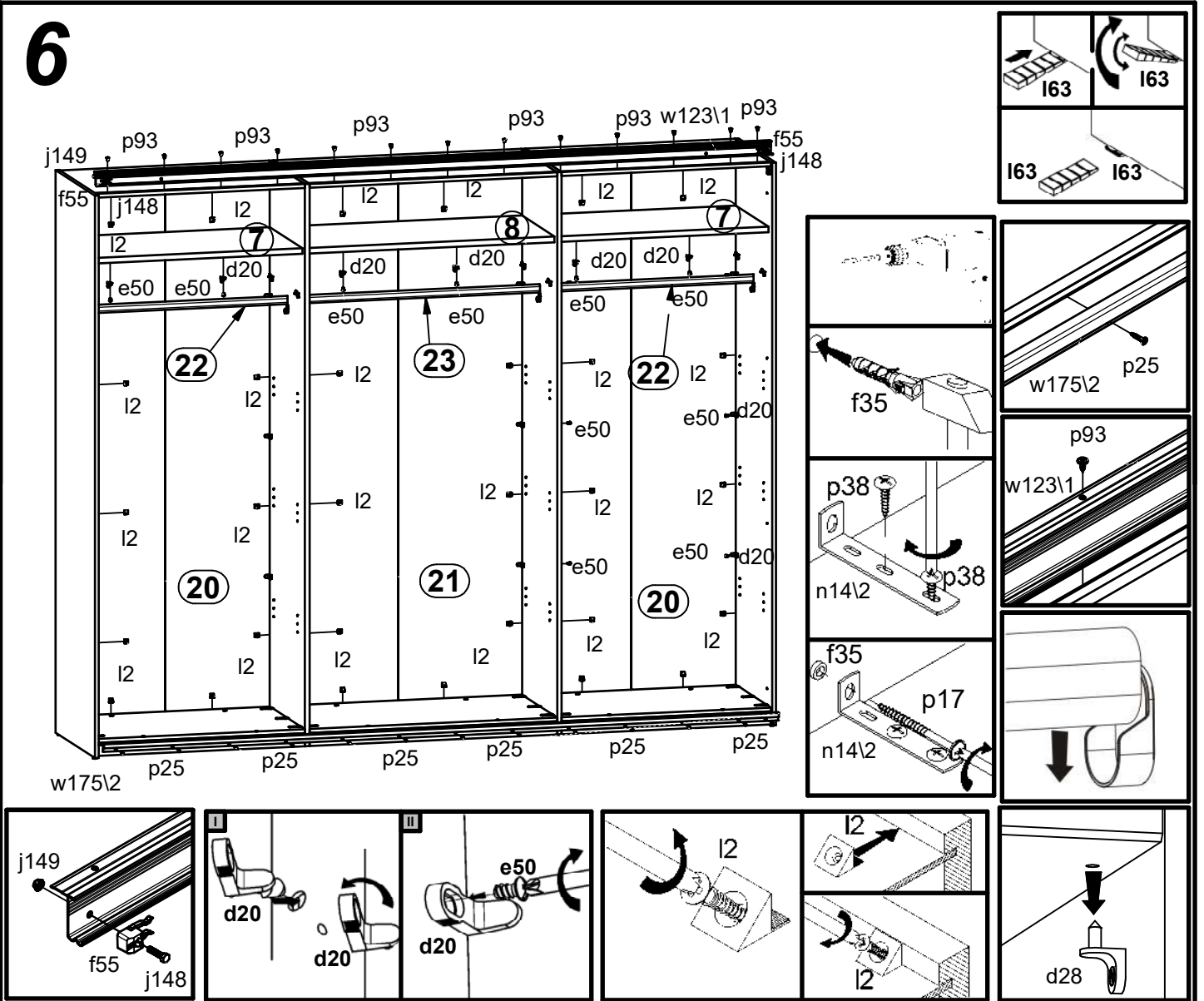

# 7

## 2x

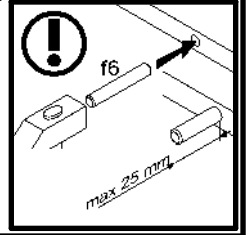
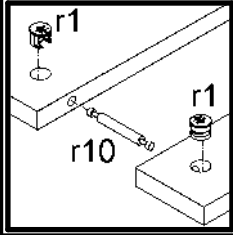
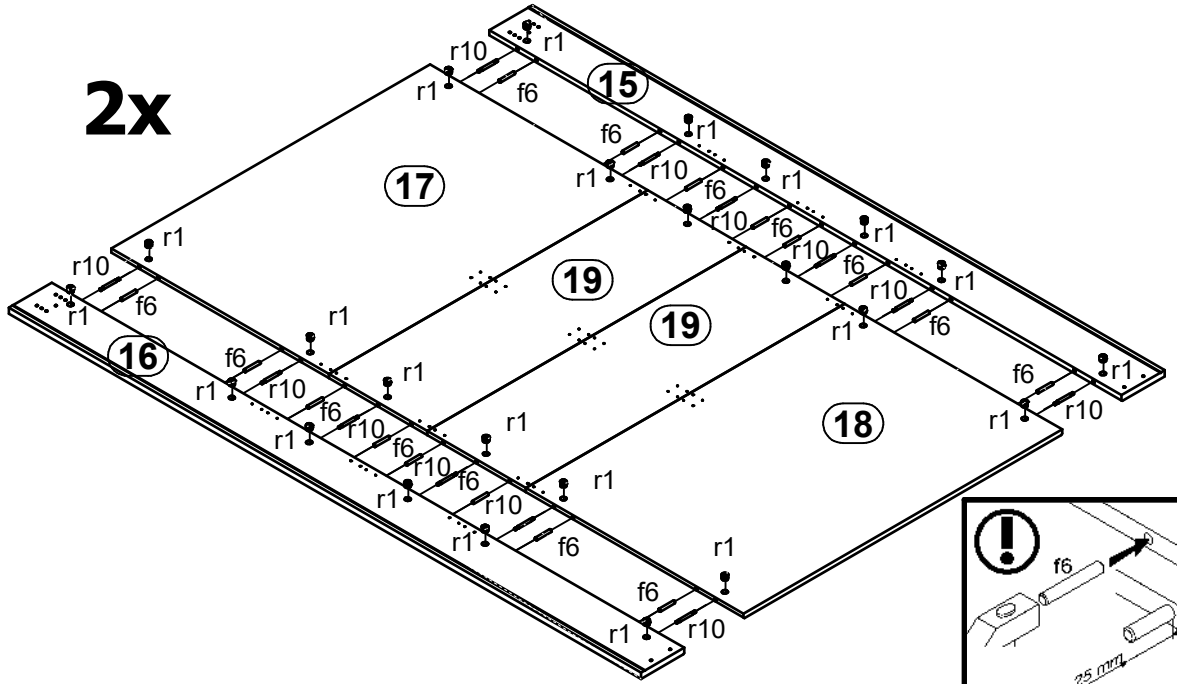

# 8

