

58-303-87
58-303-17

F27-SZF/125/195/3

A	B	C	D	
1	F27-104	1950	580	1/3
2	F27-105	1950	551	1/3
3	F27-106	1853	485	1/3
4	F27-305	1220	535	2/3
5	F27-306	1220	550	2/3
6	F27-307	827	480	2/3
7	F27-308	378	480	2/3
8	F27-403	1220	66	2/3
9	F27-404	1220	66	2/3
10	F27-504	635	230	3/3
11	F27-505	835	635	3/3
12	F27-506	835	635	3/3
13	F27-902	1878	847	1/3
14	F27-903	1878	397	1/3

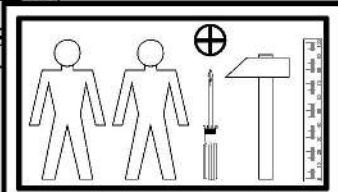
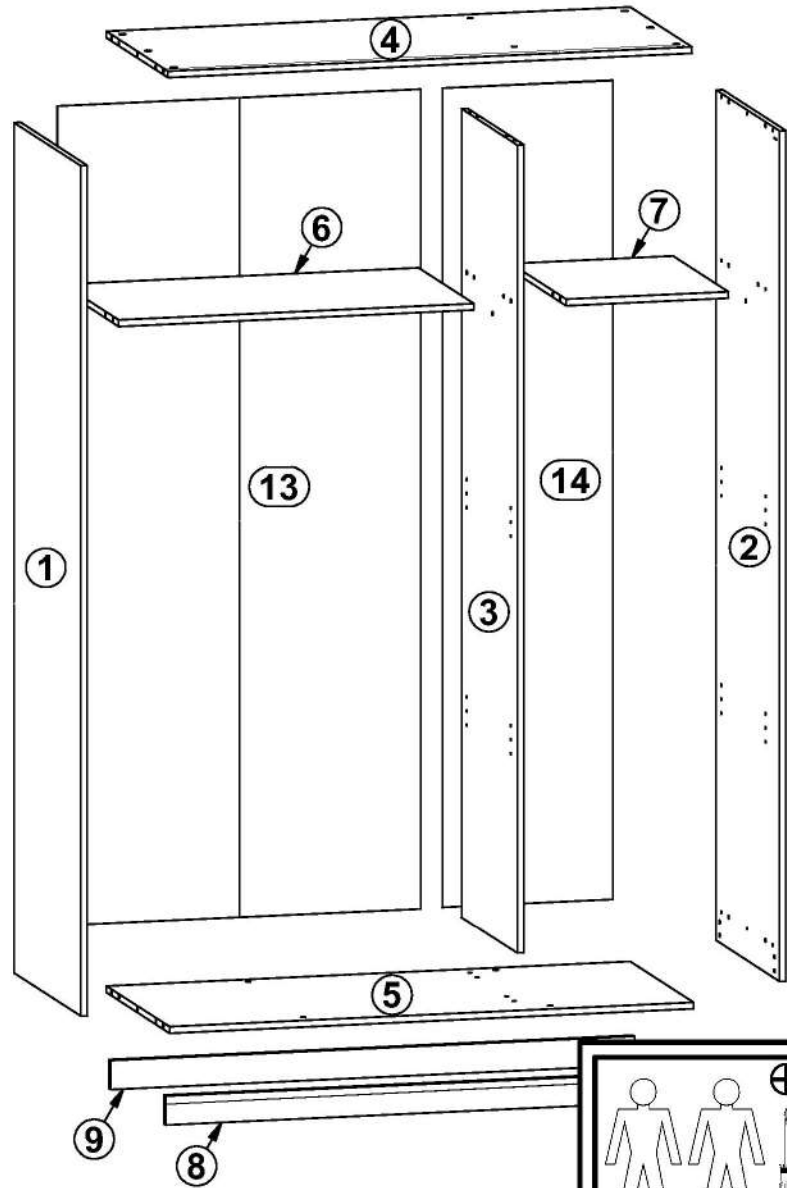
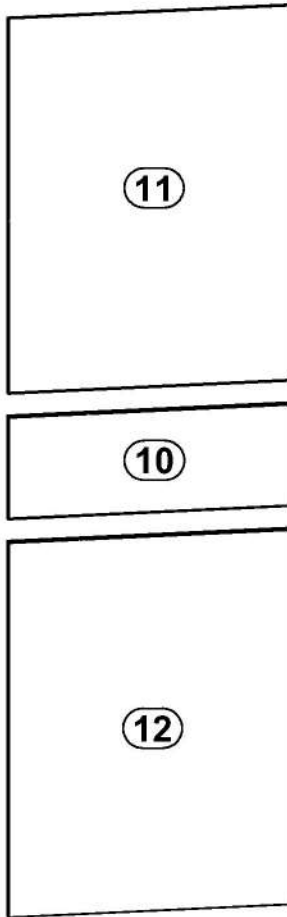
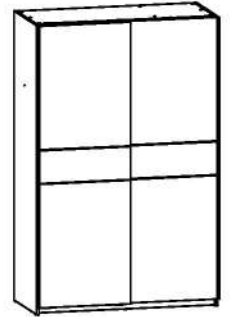

1x dr-821	1x dr-373	8x e1 Ø7x50 mm	28x f1 Ø8x30 mm	2x f20	6x k1	50x l1	4x n1	10x n108 20x13x3.5/1
2x n142	2x n143	1x n144	2x n146	2x n147	4x n76	2x n145	4x p16 Ø3.5x25 mm	32x p19 Ø4x16 mm
11x p25 Ø3.5x16 mm	10x p55 Ø2.9x16 mm	77x p93 Ø4x13 mm	20x r1 Ø15x12 mm #16	2x r10	16x r42	2x p60 Ø4x22 mm	2x w118/3 1800 mm	2x w118/4 1800 mm
1x w95/4 1216 mm	1x w96/4 1216 mm	4x s1	8x s2 Ø16	1x z1				

1

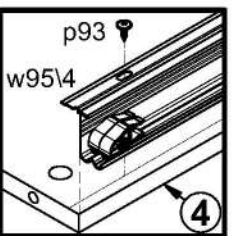
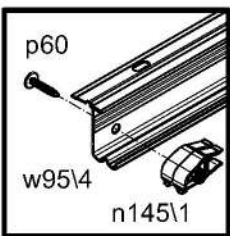
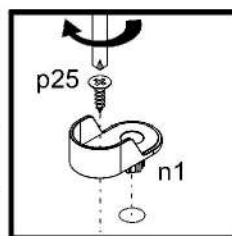
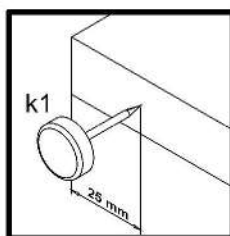
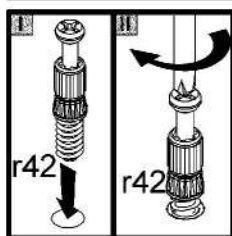
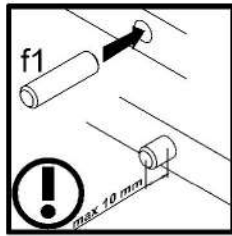
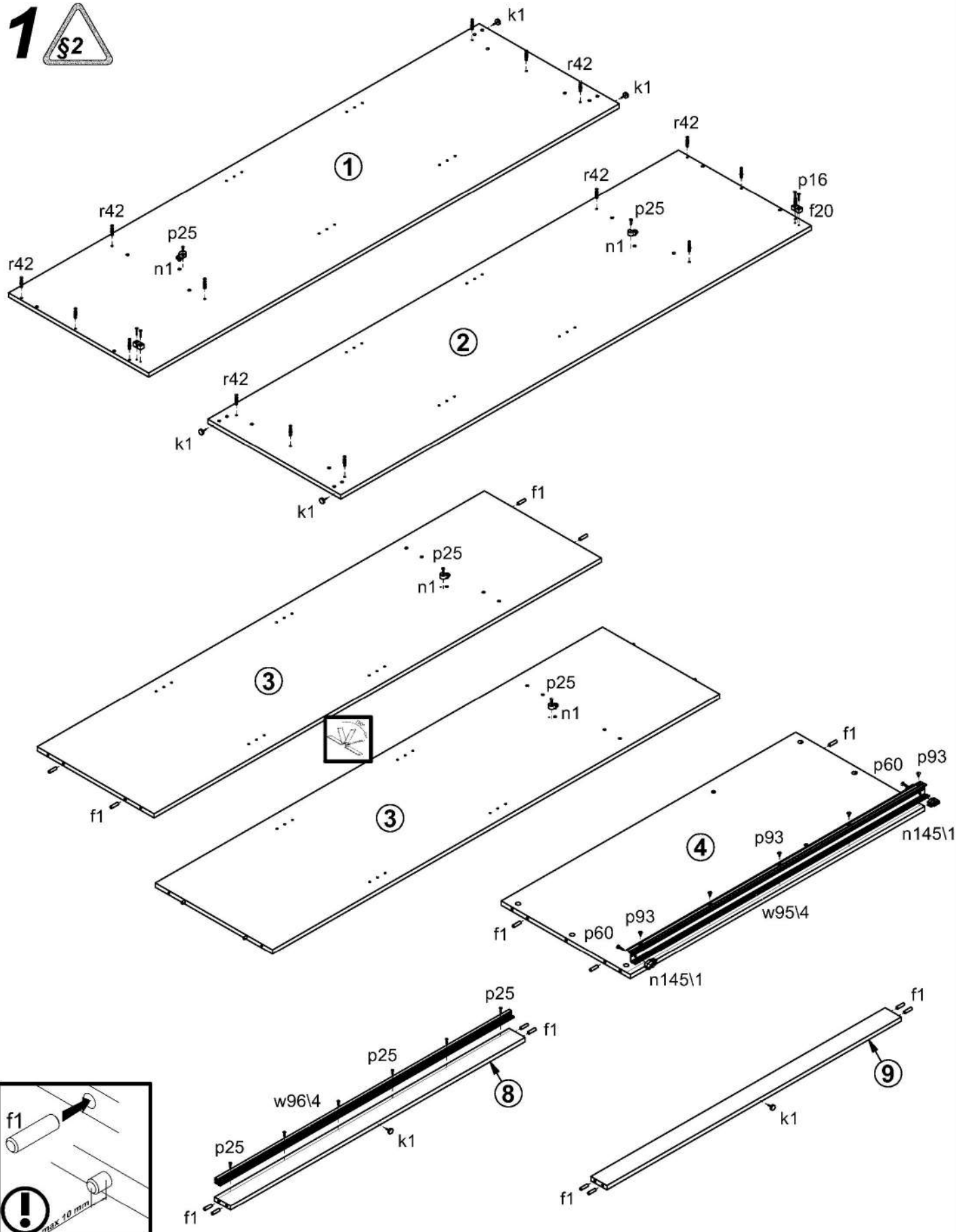

2

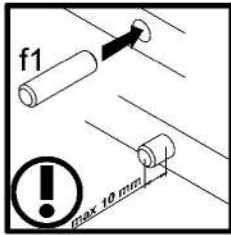
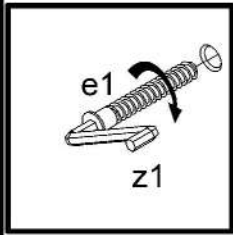
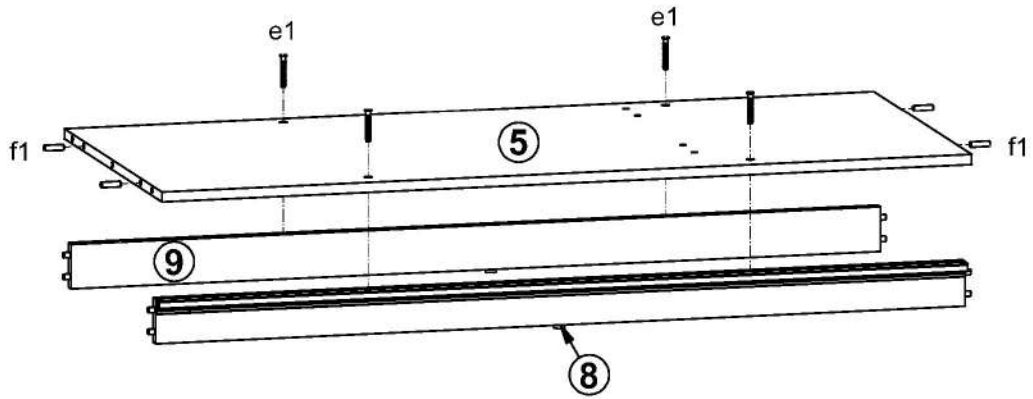

3

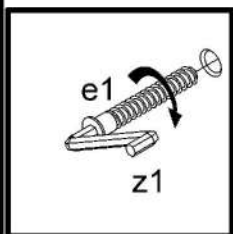
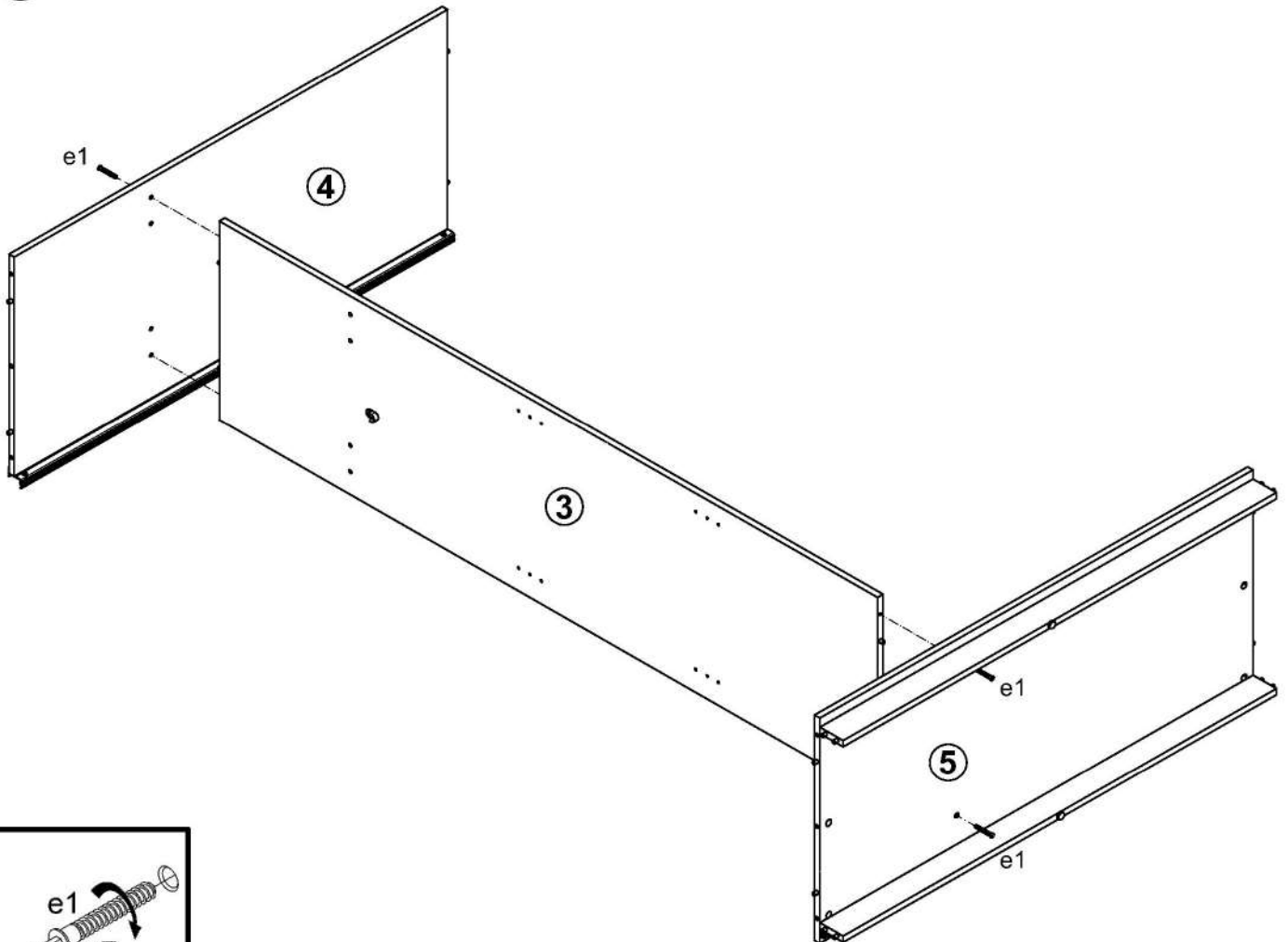

4

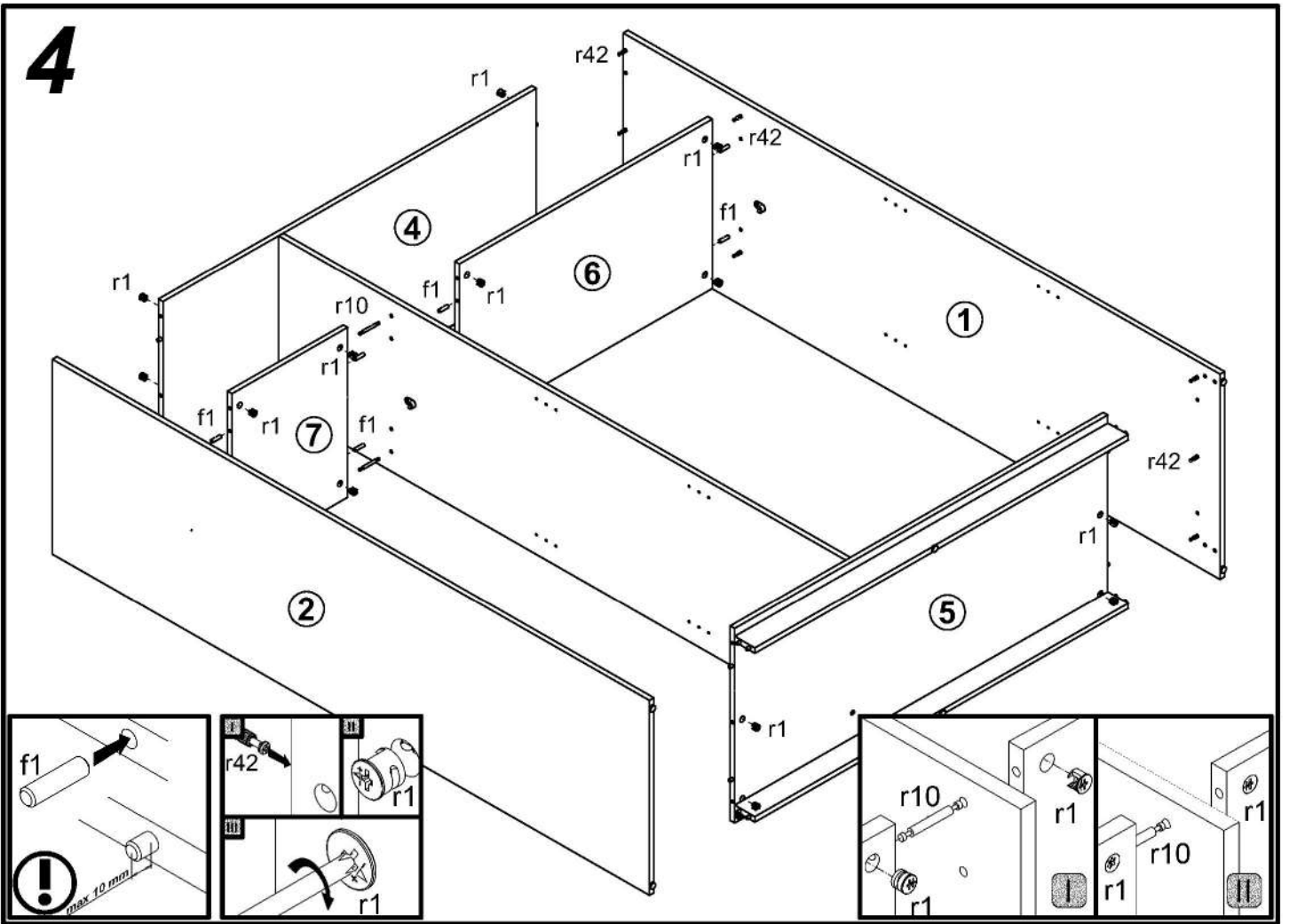

5

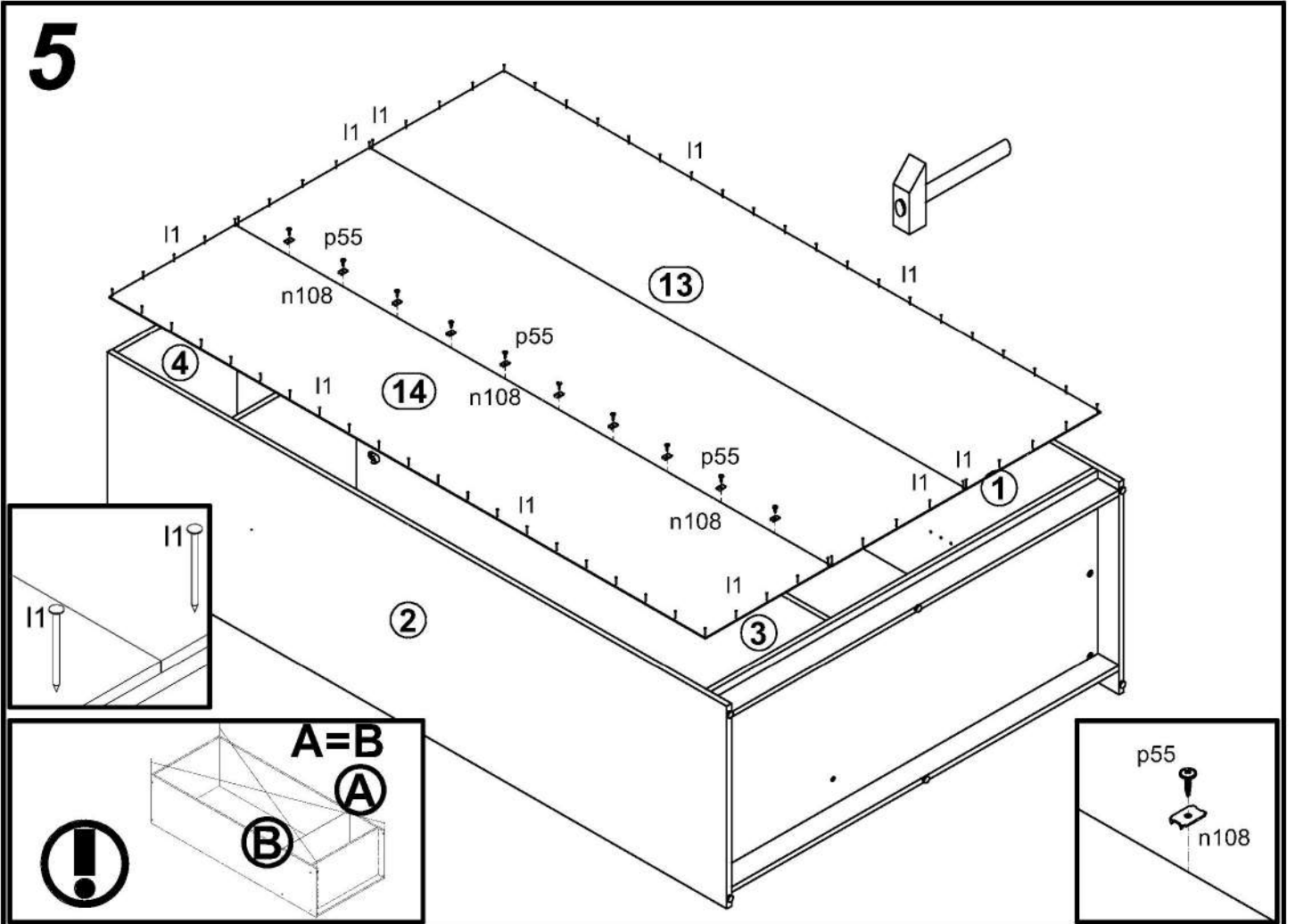

6

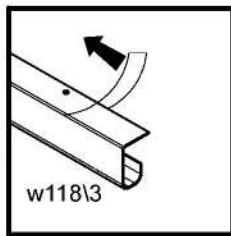
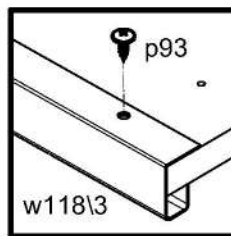
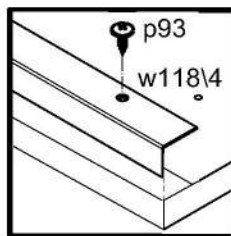
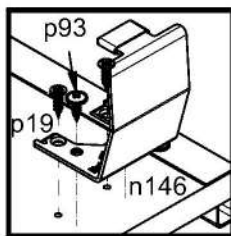
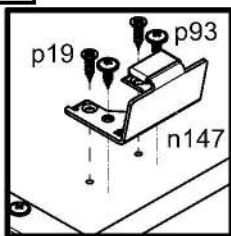
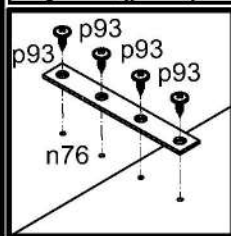
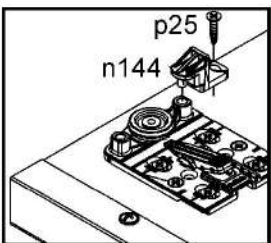
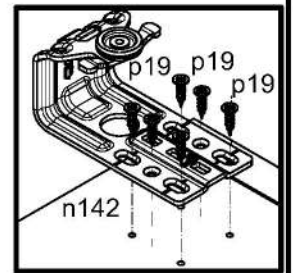
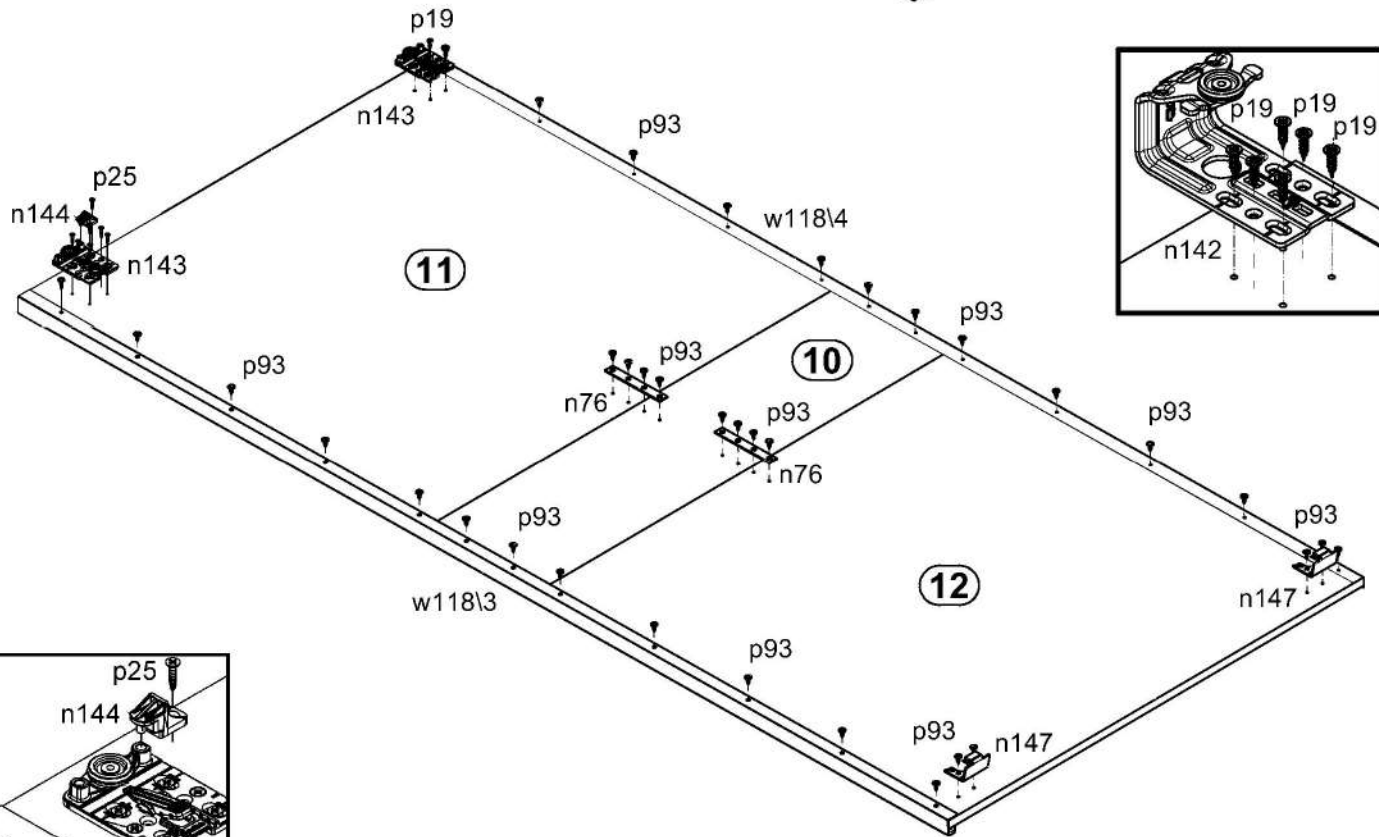
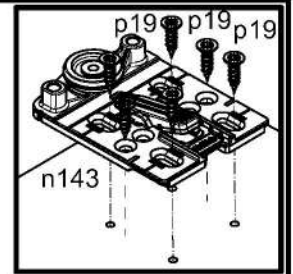
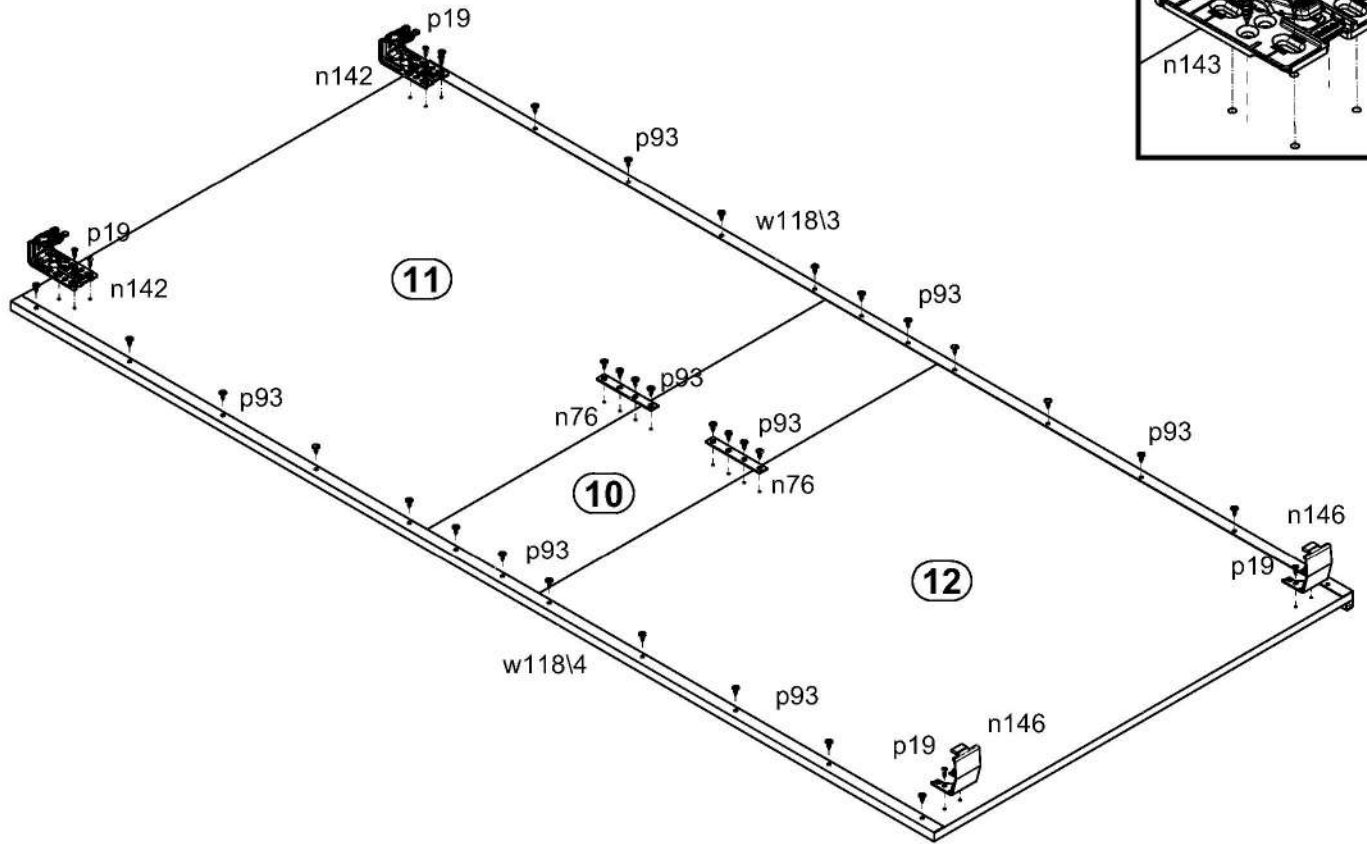

7

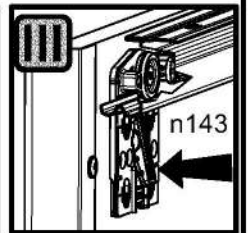
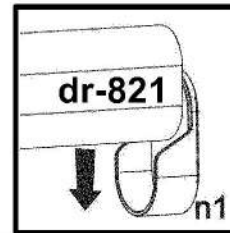
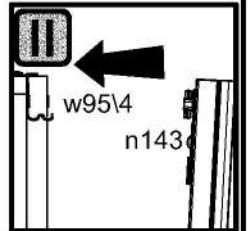
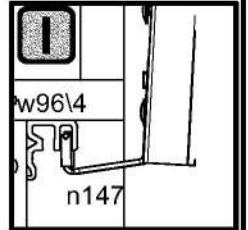
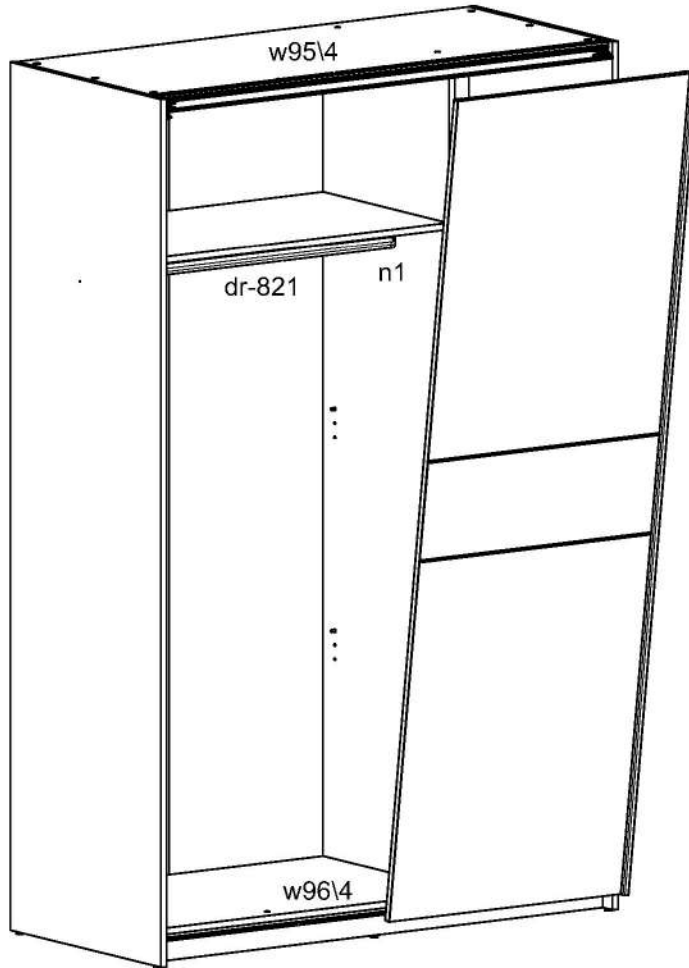

8

